

GE
Sensing & Inspection Technologies

Druck DPI 610/615 IS

Intrinsically Safe Portable Pressure Calibrator

User manual - K0430

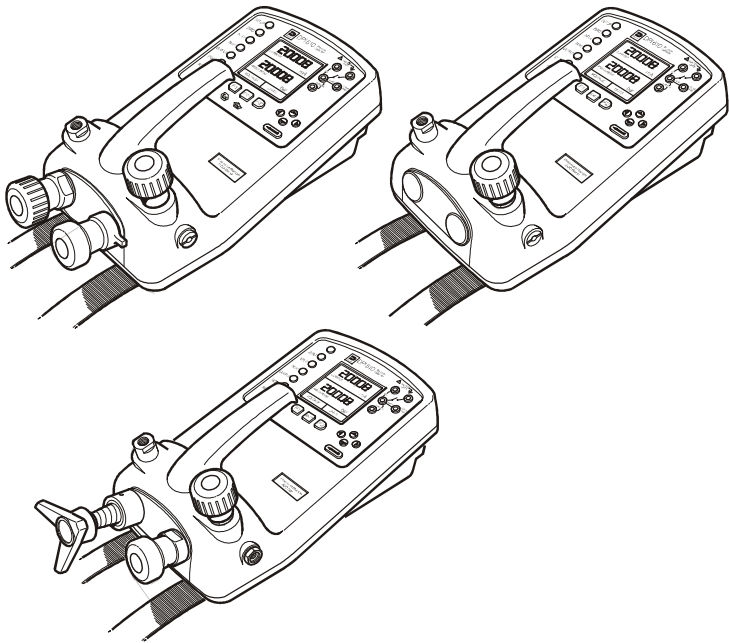

English

To select the manual in an available language go to:

[//www.gesensing.com/toolsupport/manuals.htm](http://www.gesensing.com/toolsupport/manuals.htm)

Français

Pour choisir le manuel dans une langue disponible, accédez à :

[//www.gesensing.com/toolsupport/manuals.htm](http://www.gesensing.com/toolsupport/manuals.htm)

Deutsch

Um das Handbuch in einer vorhandenen Sprache auszuwählen, gehen Sie zu:

[//www.gesensing.com/toolsupport/manuals.htm](http://www.gesensing.com/toolsupport/manuals.htm)

Italiano

Per scaricare il manuale in una delle lingue disponibili consultare la pagina:

[//www.gesensing.com/toolsupport/manuals.htm](http://www.gesensing.com/toolsupport/manuals.htm)

Español

Para seleccionar el manual en uno de los idiomas disponibles vaya a:

[//www.gesensing.com/toolsupport/manuals.htm](http://www.gesensing.com/toolsupport/manuals.htm)

Português

Para seleccionar o manual em uma língua disponível vá para:

[//www.gesensing.com/toolsupport/manuals.htm](http://www.gesensing.com/toolsupport/manuals.htm)

WARNING

Before operating this intrinsically safe instrument, read the safety instructions and the special conditions stated on the ATEX certificate (Appendix 2)

Safety

The manufacturer has designed this equipment to be safe when operated using the procedures detailed in this manual. Do not use this equipment for any other purpose than that stated.

This publication contains operating and safety instructions that must be followed to ensure safe operation and to maintain the equipment in a safe condition. The safety instructions are either warnings or cautions issued to protect the user and the equipment from injury or damage.

Use suitably qualified * technicians and good engineering practice for all procedures in this publication.

Pressure

Do not apply pressures greater than the safe working pressure to this equipment.

Maintenance

The equipment must be maintained using the procedures in this publication. Further manufacturer's procedures should be carried out by authorized service agents or the manufacturer's service departments.

www.gesensinginspection.com

For technical advice contact the manufacturer.

* *A qualified technician must have the necessary technical knowledge, documentation, special test equipment and tools to carry out the required work on this equipment.*

Symbols



This equipment meets the requirements of all relevant European safety directives. The equipment carries the CE mark.



This symbol, on the instrument, indicates that the user should refer to the user manual. This symbol, in this manual, indicates a hazardous operation.



This symbol, on the instrument, indicates do not throw-away in domestic bin, hazardous material, dispose correctly in accordance with local regulations.



GE Druck

EC Declaration of Conformity

Product: DPI 610/615 (IS) PORTABLE PRESSURE CALIBRATOR SERIES

The above product(s) meets the protection requirements of the relevant EC Directives.

Supplier: Druck Ltd., Fir Tree Lane, Groby, Leicester LE6 0FH.
Tel: +44 (0) 116 231 7100 Fax: +44 (0) 116 231 7101

Signed: 
For and on behalf of Druck Limited

Date: 6th Jan 2009

Name: R Jones

Position: Group Engineering Director

Relevant European Directives	
Directive Name	Directives
Low Voltage Directive	2006/95/EC
Electromagnetic Compatibility	2004/108/EC
Pressure Equipment Directive	97/23/EC (Category SEP)
Potentially Explosive Atmospheres	94/9/EC †

† The ATEX directive only applies to instruments marked with BAS02ATEX1174X

Standards	
Standard Name	Standard
Safety requirements for electrical equipment for measurement, control and laboratory use	EN61010-1:1993
Electromagnetic Compatibility	EN50081-1:1992 and EN50082-1:1997
Electrical apparatus for explosive atmospheres - General Requirements	EN60079-0:2006 ‡
Electrical apparatus for potentially explosive atmospheres intrinsic safety "i"	EN60079-11:2007 ‡
Explosive atmospheres. Equipment with equipment protection level (EPL) Ga	EN60079-26:2007 ‡

‡ These standards only apply to instruments marked with BAS02ATEX1174X

ATEX Approved Models

Introduction

These instructions detail the requirements for using the DPI 610 IS and DPI 615 IS intrinsically safe pressure calibrator in a hazardous area. Read the whole publication before starting.

Markings



II 1 G Equipment group & category
Ex ia IIC T4 Ga Hazardous location markings
BAS02ATEX1174X Certificate number



1180 CE Mark
DPI 61X IS Specific apparatus type
(Pressure Range in mbar or psi Full-scale pressure rating
Druck LTD. Groby LE6 OFH, UK Manufacturer's name and address
SN *****/YY-MM Serial number and date of manufacture,
Year-Month.

Requirements and Conditions

Batteries

WARNING: Only replace batteries in a safe area.

- Power supply use only 6 x LR14 (C): Duracell MN1400-LR14, Procell Industrial MN1400-LR14, Energizer E93.KR14.C.AM2, Energizer Industrial EN93 or Varta 4014 LR14.C.AM2.

Special Conditions for Safe Use

1. The DPI 61X IS Series Pressure Calibrator is not capable of withstanding the 500V r.m.s. electric field strength test between the external connectors and frame of the apparatus as required by Clause 6.4.12 of EN 50020 and this must be taken into account when using the apparatus for input measurements in a system.
2. The outer enclosure may contain light metals in the form of aluminium, magnesium, titanium or zirconium. Therefore, the apparatus must be installed in such a manner as to prevent the possibility of it being subject to impacts or friction. An optional carrying case is available for transporting the pressure calibrator to and from the location of use. When the carrying case is used, special condition for safe use item #2 does not apply.

Electrical Parameters

Maximum Output Parameters at the External Measurement Connectors:

Iin (SK1)	Vin (SK2)	SwitchIn (SK3)
$U_o = 1.1V$ d.c.	$U_o = 1.1V$ d.c.	$U_o = 1.1V$ d.c.
$I_o = 0.16$ mA d.c.	$I_o = 0.11$ μA d.c.	$I_o = 12$ mA d.c.
$P_o = 0.15$ mW	$P_o = 0.03$ μW	$P_o = 11$ mW
$C_i = 0.05$ μF	$C_i = 0$	$C_i = 0.05$ μF
$L_i = 0$	$L_i = 0$	$L_i = 0$
Iout (SK6)	RS232	External Transducer
$U_o = 7.9V$ d.c.	$U_o = 7.6V$ d.c.	$U_o = 7.6V$ d.c.
$C_i = 0$	$I_o = 82$ mA d.c.	$I_o = 155$ mA d.c.
$L_i = 0.1$ mH	$P_o = 162$ mW	$P_o = 0.43$ W
	$C_i = 0$	$C_i = 0.15$ μF
	$L_i = 0$	$L_i = 0.9$ mH
	$U_m = 250V$	$C_o = 8.6$ μF
		$L_o = 0.3$ mH

The output parameters at sockets SK1, SK2 and SK3 do not exceed the values specified in Clause 5.4, Simple Apparatus, of EN 50020.

Maximum Safe Input Parameters:

Sockets SK1, SK2, SK3 and SK6

$$U_i = 30V$$

$$I_i = 100$$
 mA

$$P_i = 1.0W$$

Installation

WARNING: Do not use tools on the pressure calibrator that might cause incendive sparks - this can cause an explosion.

- Provide additional protection for equipment that may be damaged in service.
- Installation should be carried out by qualified plant installation technicians in compliance with the latest issue of EN 60079-14.

Declaration Requirements

The DPI 610 IS and DPI 615 IS pressure calibrators are designed and manufactured to meet the essential health and safety requirements not covered by the EC Type Examination Certificate BAS02ATEX1174X when installed as detailed above. The intrinsically safe pressure calibrators are designed and manufactured to protect against other hazards as defined in paragraph 1.2.7 of Annex 11 of the ATEX Directive 94/9/EC.

Specification

Safe working pressure

20 bar range (300 psi)	1.75 x full-scale
350 bar range (5000 psi)	1.2 x full-scale
400 bar range (6000 psi)	1.5 x full-scale
All other ranges	2 x full-scale

Accuracy

Combined non-linearity, hysteresis and repeatability

±70 mbar range (2 inHg)	0.05% F.S.
up to ±150 mbar (4.4 inHg)	0.05% span
200 mbar to 20 bar (3 psi to 300 psi) [Calibrator]:	0.025% F.S.
35 bar to 700 bar (500 psi to 10000 psi) [Indicator]	0.025% F.S.
70 bar to 400 bar (1000 psi to 6000 psi) [Hydraulic]	0.025% F.S.

Pressure Ranges

Refer to the pressure range matrix in the data sheet.

Temperature Effects

±0.004% of reading/°C (averaged over -10° to +40°C w.r.t. 20°C)
±0.002% of reading/°F (averaged over +14° to 104°F w.r.t. 68°F)

Power supply

Batteries 6 x 1.5 V C cells, alkaline (up to 60 hours nominal use at 20°C)

Voltage Inputs

Range:	±30V
Accuracy	±0.05% rdg, ±0.004% F.S.
Resolution	100µV max

Current Inputs

Range:	±55mA
Accuracy	±0.05% rdg, ±0.004% F.S.
Resolution	1µA max

Current sink

Range:	24mA
Accuracy	±0.05% rdg, ±0.01% F.S.
Resolution	1µA max

Display

Size:	60 x 60 mm (2.36" x 2.36") LCD Graphics
Reading	±99999, update rate 2 readings/sec

Environment

Operating Temperature:	-10°C to 50°C (+14°F to 122°F)
Calibrated Temperature:	-10°C to 40°C (+14°F to 104°F)
Storage Temperature:	-20°C to 60°C (-4°F to 140°F)
Calibration Temperature:	21°C ±2°C (70°F ±4°F)

Sealing

Sealed to IP54 (NEMA 4)

Physical

Size:	300 x 170 x 140 mm (11.8" x 6.7" x 5.5")
Weight:	3 kg (6.6lb)

Introduction

General

Description of Procedures 1

Summary of Functions

Using this Guide 2

OPERATOR CONTROLS 3

DISPLAY 3

HARD KEY FUNCTIONS 4

SOFT KEYS 5

CURSOR KEYS 5

ELECTRICAL CONNECTIONS 6

Getting Started

Fitting Batteries 7

Switching On 7

Change Pressure Units 8

Voltage and Current Measurement 8

Typical Calibration Set-up (Pressure to Voltage) 9

Zero Display Reading 9

Task Selection

Task Key 10

Using Task Functions 10

Set Units 10

Cal Mode (DPI 615 instruments only) 11

Basic Mode (Task BASIC) 11

Taking Measurements

Pressure Transmitter (P-I) Task 12

Voltage Output Pressure Transmitter (P-V) Task 12

Pressure Converter (P-P) Task 13

Current to Pressure Converter (I-P) Task 14

Pressure Switch Test (P-Switch) Task 14

Pressure to Display (P-Display) Task 15

Leak Test (Leak Test) Task 16

Transmitter Simulator (TX SIM) Task 17

Relief Valve Test (REL VALVE) Task 18

Advanced Task

General	19
Select Input	19
Ambient Temperature Measurement	19
Process Functions	20
Tare Process Function	21
Min/Max Process Function	22
Filter Process Function	22
Flow Function	23
% Span	23
Select Output	24
Electrical Outputs (Loop Power)	24
mA Step	25
mA Ramp	26
mA Value	27
Define New Task	28
Clear Task	28

Memory Operations

Saving Display or Data Log	29
Store Operations (Screen Snapshots)	29
Recalling Stored Data (Screen Snapshots)	29
Datalog Operations	30
Auto Log (Timer)	30
Manual Logging	30
Recall Data Log Files	31
Uploading Data Log Files	32
Delete Data Log and Procedure Files	32
Downloading Procedure Files (DPI 615 instruments only)	33
Running Procedure Files (DPI 615 instruments only)	34
Recalling Data Files (DPI 615 instruments only)	35

Using Set-up

General	36
Store Mode	36
Contrast	36
Settings - Select Set-up Option	37
<i>Units</i>	37
<i>Define Special Units</i>	37
<i>Language</i>	38
<i>RS232</i>	38
<i>Powerdown</i>	39
Calibration	39

Date and Time (Real Time Clock)	40
<i>Date Format</i>	40
<i>Set Date</i>	40
<i>Set Time</i>	40
Calibration	
General	41
Calibration Check	41
Calibration Adjustment	41
Guide to Calibration Procedures	41
Test Equipment	42
Using the Calibration Menu	43
Change PIN	43
Calibrate Internal Ranges	43
Internal Pressure Range	44
Voltage Input Range (5 Volts)	45
Voltage Input Range (30 Volts)	47
Current Input Range (55 mA)	49
Current Output Range (24 mA)	51
Ambient Temperature Channel	54
Calibrate External Sensors	55
Add External Sensor	56
Hydraulic Calibrator Versions	
Introduction	59
Safety Instructions	60
Preparation for Use	60
Bleeding the System	61
Operation	62
Draining the Hydraulic Fluid	62
Flushing, Replenishing or Changing the Hydraulic Fluid	63
Appendix 1 - Datalog File Example	
Typical Uploaded Datalog File (DPI 610)	67
Typical Uploaded Procedure Data File (DPI 615)	68
Appendix 2 - ATEX Certificate of Conformity	

General

The DPI 610 IS and DPI 615 IS intrinsically safe instruments measure and **display pneumatic** and **hydraulic** pressure applied to the **test** port. Pressure measurement can be **absolute**, **gauge** and **sealed gauge** and in ranges from **2.5 mbar to 700** bar (1.0 inH₂O to 10000 psi).

Calibrator versions of this instrument contain **pneumatic** or **hydraulic** pressure generation components to produce pneumatic pressure ranges between -1 to 20 bar (-14.5 psi to 300 psi) and hydraulic pressure ranges up to 400 bar (6000 psi) Using external **electrical** connections, the DPI 610 IS and DPI 615 IS **intrinsically** safe instruments measure **±30 volts** d.c. and **±55 mA**. An integral sensor provides measurement of **ambient** temperature. Additional sensors (option B1) connect to an external connector and extend the pressure measurement range and include differential pressure measurement. The DPI 615 instrument has an **RS232 connector** to enable **downloading** of test data to a **compatible** documenting system. **Six alkaline C size** batteries, IEC Type LR14, power the instrument.

Important Notice
 Zinc-carbon and zinc-chloride cells must **NOT** be used in this instrument.
 Use only the battery types as shown in the table on page 7.

Description of Procedures

The procedures apply to both the DPI 610 IS and the DPI 615 IS instruments unless otherwise stated. In the procedures in this manual, hard (fixed function) and soft (variable function) key operations are shown in bold type : **TASK** and **F1**. These statements mean press the **TASK** key and press the **F1** key. Soft key operations can be assigned to both the F1 and F2 keys. Where a specific soft function is referred to it is written in bold italics (e.g.) **PROCESS**.

This instrument has a number of operating modes that are described in simplified form in the following sections. Diagrams accompanying the procedures give typical selection sequences and shaded controls indicate that this control key should be pressed in the appropriate sequence. Diagrams should be read from left to right, top to bottom where appropriate. A shaded display soft box indicates that the function key immediately below that soft box should be pressed (either **F1** for the left hand soft box or **F2** for the right).

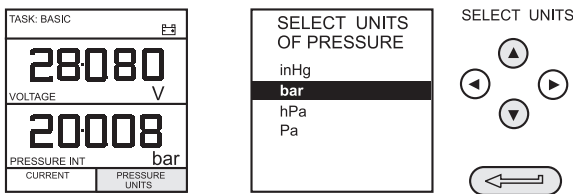

In the above diagram the following key sequence is indicated.

- (a) Press the F2 key (the key immediately below the **UNITS** soft box).
- (b) Use the **Up** and **Down** cursor keys (only) to select the required option. (If all keys shaded, use all these keys to select or enter data).
- (c) Press the **ENTER** key.

Using This Guide

The following key symbols are used in the procedure diagrams:

SELECT VALUE

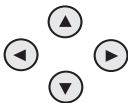

Shaded cursor keys indicate that a combination of these four keys, Up, Down, Left and Right should be used to (e.g.) enter an alpha numeric value or to select a function.



Indicates the **ENTER** key. Used to confirm an operation or a selection. Shading indicates key operation.



Exit key, used to clear current menu selection and return to next menu level above current level. Used as an escape key from current operation. Shading indicates key operation.

RECALL ○

Hardkey (total 7). Legend beside key symbol indicates function. Shading indicates key operation.

Maximum Instrument Ratings

The following table shows the maximum measurement input ratings of the instrument which should not be exceeded.

PRESSURE	120% FULL SCALE
VOLTAGE	30 V d.c.
CURRENT	55 mA d.c.

Note 1: The **display flashes** if the input pressure, voltage or current overrange.

Note 2: Max applied voltage for external loop supply = 30V dc (see page 8).

OPERATOR CONTROLS (Figure 1 and 2)

These divide into two groups, the operator/display controls (Figure 1) and the pressure/vacuum generation components (Figure 2). The operator controls and a typical display, common to all instrument versions, is shown below.

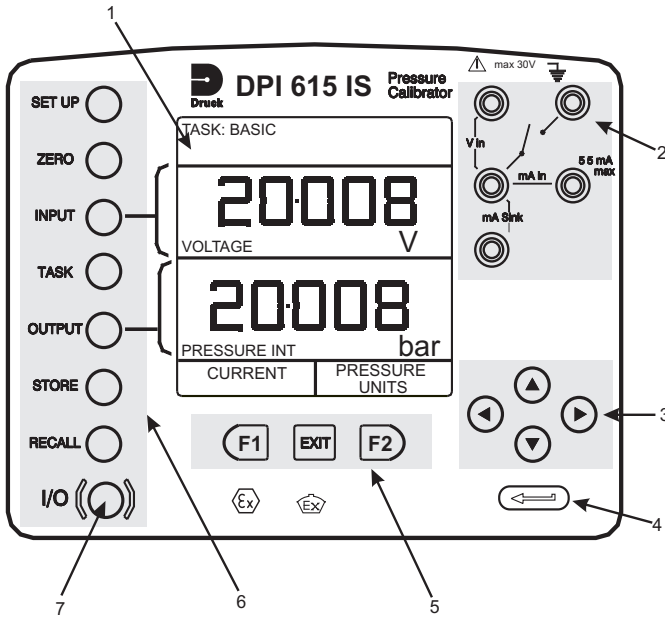

- 1 Display 2 Electrical Measurement Input Sockets 3 Cursor Keys
- 4 Enter Key 5 Function (soft) Keys 6 Hard Keys 7 On/Off Key

Figure 1 - DPI 610/615 IS Key-pad

DISPLAY

The display and key-pad of the instrument **divides into four distinct sections**. The two main sections of the display are used to show an **input and an output**. The remaining two sections show the **status display area and define the soft key functions**. A typical display is shown below:

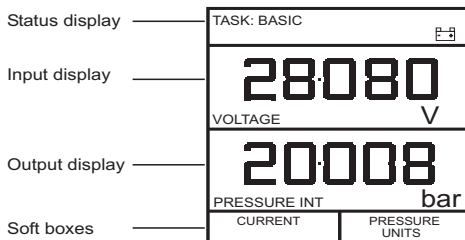

HARD KEY FUNCTIONS (Fig. 1)

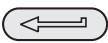
Key	Function	Page reference
I/O	This key selects the instrument ON and OFF.	7
SETUP*	The SETUP key provides access to the instrument's general configuration parameters that are set-up to certain default parameters on delivery.	36
ZERO	The ZERO key zeroes either the selected input or output display, only if the display reading is within 5% of zero. Attempts to zero a larger offset result in an error message, Zero too large .	9
INPUT*	The INPUT key selects the input parameter to be displayed.	18, 19
TASK	The TASK key rapidly configures the instrument for a number of different types of external device calibration. There are twenty task configurations available, eleven pre-programmed configurations and nine user defined configurations	10
OUTPUT*	The OUTPUT key selects the output parameter to be displayed.	24-27
STORE*	Depending upon how the instrument's STORE mode is set-up, this key is used either to store up to 20 display screens (in SNAPSHOT mode), or to manually log a screen in DATALOG mode.	29, 36
RECALL*	This key recalls a previously stored screen to the display. Depending on the STORE mode set-up, operation of this key recalls either the snapshot of a previously stored screen or data log file. In STORE mode, selection displays the last screen stored. By using the cursor keys, the operator can scroll either forward or back through memory locations.	28, 31, 35
ENTER 	The ENTER key either enters data (accept entered data), or, in conjunction with the soft keys, accepts a given selection.	2
EXIT	The EXIT key operates in conjunction with all the other hard and soft keys to exit from the current screen or menu level, to the level immediately preceding it. To quit completely from any menu level, press EXIT until the MEASURE/SOURCE screen is displayed.	2

* These key functions are not available in BASIC mode

SOFT KEYS (Fig. 1)

Three soft keys, designated **F1**, **EXIT** and **F2**, are situated immediately below the display as shown below. These keys have their function allocated by the instrument software which is indicated in the bottom of the display (Voltage for **F1** and Units for **F2** in this example). They are used to select menu (program) options and are fully described under the appropriate section headings.

CURSOR KEYS (Fig. 1)

The cursor keys consist of a block of four keys, designated **up ▲**, **down ▼**, **left ◀**, and **right ▶**. In programs where options need to be selected from a list, (e.g.) the **TASK** selection program, the **up ▲** and **down ▼** cursor keys are used to highlight one of the options, from which it can be selected by the **ENTER** key. In **TASK** mode, where more than one page of options are provided, the **left ◀**, and **right ▶** cursor keys will switch between pages.

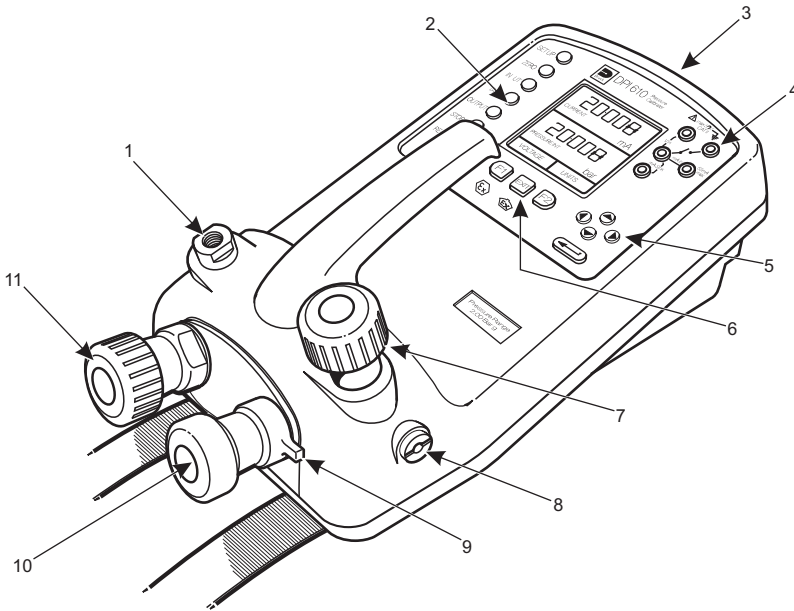

- | | | | |
|----|---|----|----------------------|
| 1 | Test port, connect to unit under test | 2 | Hard keys |
| 3 | Cover (external interfaces) | 4 | Electrical inputs |
| 5 | Cursor keys | 6 | Function (soft) keys |
| 7 | Release valve (releases pressure through 8) | 8 | Vent port |
| 9 | Select positive or negative pressure | 10 | Pump |
| 11 | Fine pressure adjuster | | |

Figure 2 - DPI 610/615 IS Calibrator Controls

ELECTRICAL CONNECTIONS

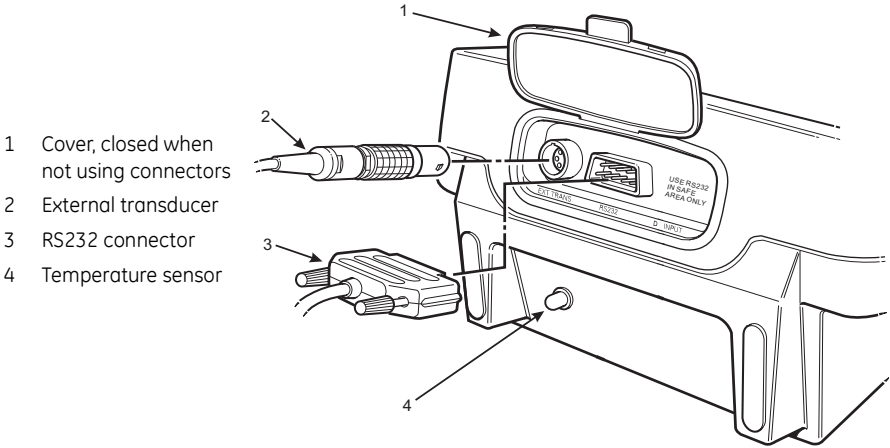

- 1 Cover, closed when not using connectors
- 2 External transducer
- 3 RS232 connector
- 4 Temperature sensor

Figure 3 - Electrical System Connections

Measurement inputs and Source outputs are made via the control panel sockets as shown below:

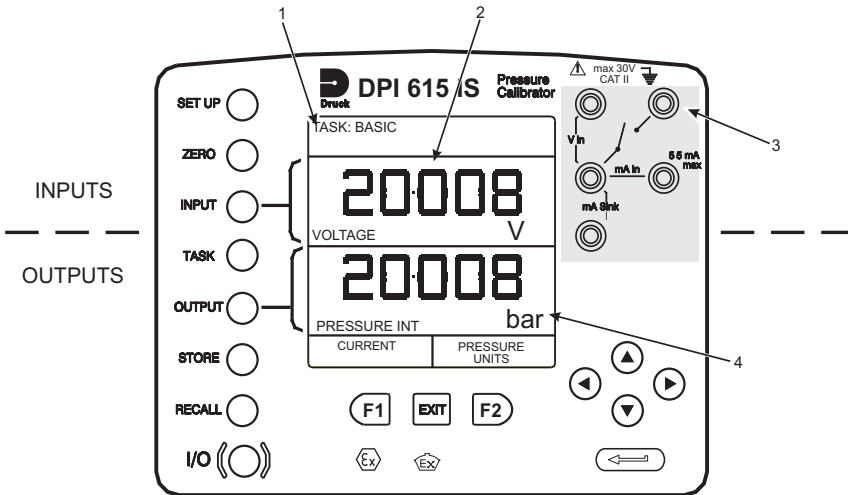

- 1 Status window
- 2 Input window
- 3 Electrical measurement input sockets
- 4 Output window

Figure 4 - Electrical Measurement Inputs/Source Outputs

Getting Started

Fitting Batteries

Manufacturer	Type No.
Energizer	Industrial Type EN93
Energizer	Type E93.LR14.C.AM2
Duracell	Type MN1400-LR14
Varta	No.4014 Type LR14.C.AM2
Procell	Industrial Type MN1400-LR14

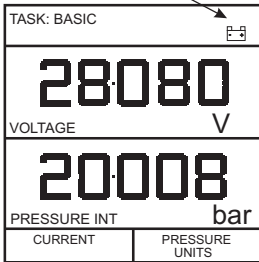
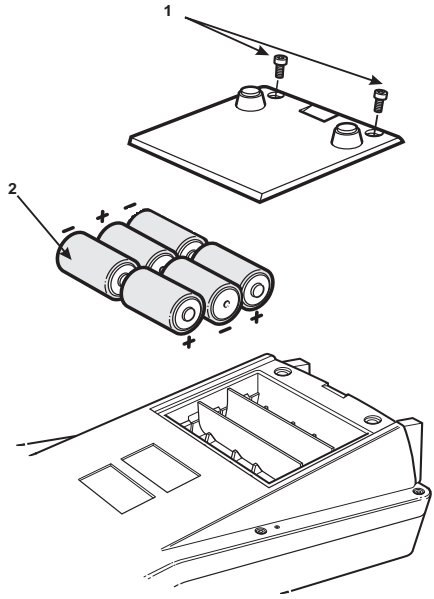

WARNING: BATTERIES MUST ONLY BE FITTED IN A SAFE AREA. USE ONLY THE BATTERIES SPECIFIED IN THE TABLE.

Caution: *Old batteries can leak and cause corrosion. Never leave discharged batteries in the instrument. Old batteries should be treated as hazardous waste and disposed of accordingly.*

Switching On

Press the I/O switch on the front panel and proceed as follows:

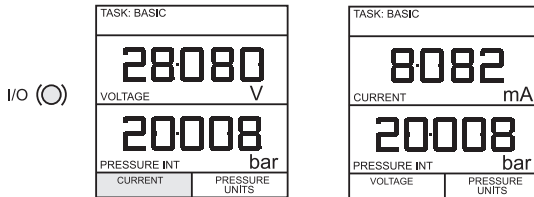

The first time that the instrument is powered up, it will power-up in **BASIC** mode with the main screen displaying voltage in the input display area and pressure in the source display area. To switch to **Current** as input, press **F1** as shown. Similarly, **F1** to return to **Voltage**.

Note: *No other keys are active in this mode and the instrument can only be reconfigured by pressing the **TASK** key and selecting another mode.*

Getting Started

Change Pressure Units

To change the pressure units proceed as follows. If the four units displayed are not the units required, press **TASK** and select any task, other than **BASIC**, press **SETUP** and proceed as detailed on page 36. To return to **BASIC** mode, press **TASK** and select **BASIC**.

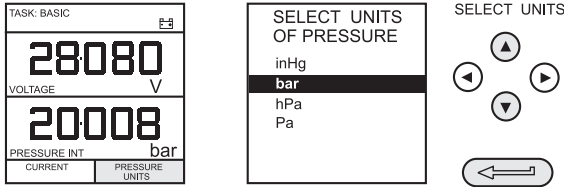

In **BASIC** mode, the unit is configured to carry out basic Pressure to Voltage (**P to V**) or Pressure to Current (**P to I**) tests, a typical test procedure follows:

Voltage and Current Measurements

Connect the electrical input sockets as follows for voltage and current measurements. Use the test leads provided and **DO NOT** push bare wires into the sockets.

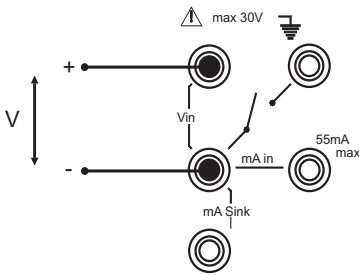

Voltage

Maximum applied voltage = 30V dc.

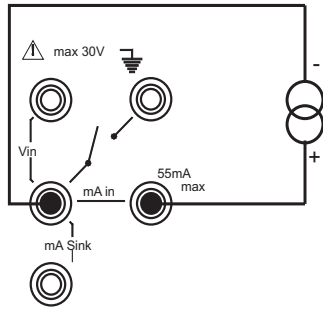

Current

Maximum input current = 55mA dc (at 30 V dc)

Getting Started

Typical Calibration Set-up (Pressure to Voltage)

Connect a device under test to the instrument as shown below:

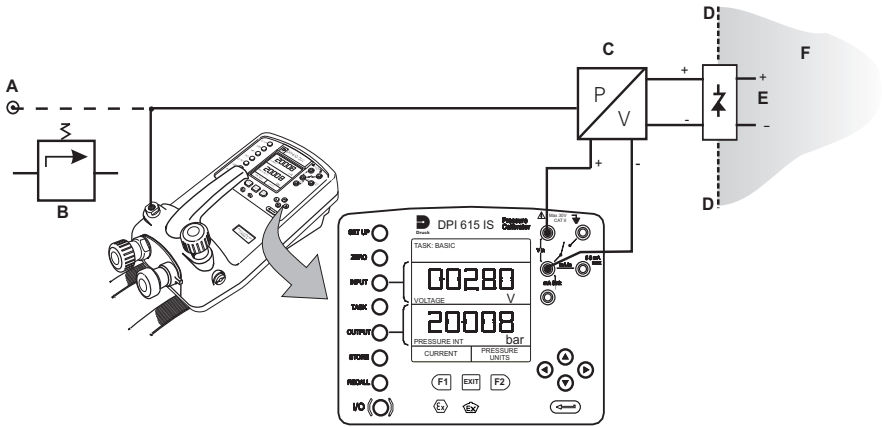

A - External pressure source (indicator instruments only) B - Pressure regulator
 C - Pressure/voltage device D - Barrier E - Excitation 10V F - Safe area

- **General Procedure**

Use the hand-pump to pressurize the system to the required level as indicated on the display. Allow the display to settle and screw the volume adjuster in or out as a fine adjustment to the required pressure. Record the input: **Voltage**, reading at each applied pressure.

Zero Display Reading

Both the input and output readings can be set to zero by using the **ZERO** key and if the displayed reading is within 5% of zero. To zero either the **INPUT** or **OUTPUT** displays, proceed as follows:



Task Selection

Task Key

The TASK key is used to set-up the instrument for a number of specific types of test. There are two modes **BASIC** and **ADVANCED** and nine other specific types of test which automatically configure the instrument on selection from the **TASK** menu. The tasks available under the **TASK** menu are held on three pages shown below. To select a task from the menu, press the **TASK** key, position the cursor over the required task and press the **ENTER** key as shown below. Use the right/left cursor keys to switch between pages.

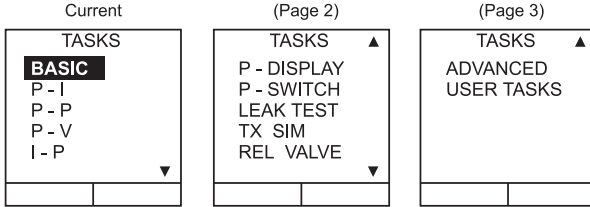

Using TASK Functions

Specific tasks are selected as shown above. The following diagrams show how to connect the unit under test (UUT) for each task selectable under the **TASK** menu.

Input and output units, where applicable, can be selected by pressing either the **INPUT** or **OUTPUT** keys as shown below.

Set Units

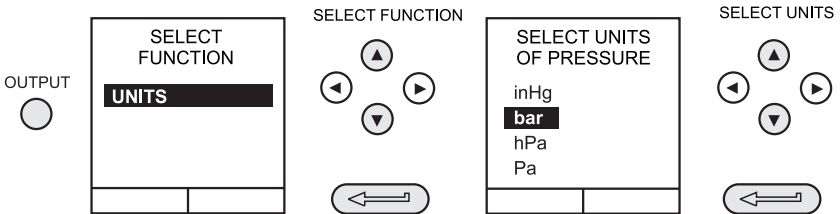

Note: If the four units displayed are not the units required, press **SETUP**, select **SETTINGS** and refer to select regular units on page 37.

Task Selection

Cal Mode (DPI 615 versions only)

Cal mode, which is available in tasks P-I, P-P, P-V, P-P, P-DISPLAY and P-SWITCH, provides a method of setting up test parameters manually. Downloaded test procedures can also automatically set up and turn on the Cal Mode function. The method of turning on and setting up Cal Mode is shown below for a P-I task. A similar method can be used for all the other tasks applicable to the Cal Mode function.

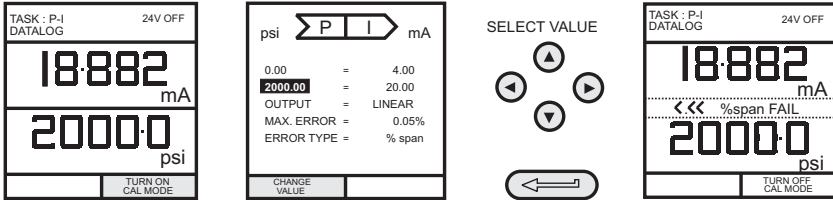

Pressing the **F1 key (TURN ON CAL MODE)**, provides the set-up screen for the CAL mode. Initially, the cursor is placed in the UUT SPAN field to allow the required span range to be entered. The corresponding values for the UUT output parameter (current) are then set, followed by the maximum error value and error type (%rdg or % span). When all test parameters have been set-up, the screen changes to display the input and output and the test results. The test result can only be displayed to within a range of $\pm 9.99\%$. If the test result is outside this range, either the left pointing (-ve error) or right pointing (+ve error) chevrons are displayed. Within this error band, the actual tolerance value is displayed. Test results can either be stored as snapshots or logged as data log files, depending on how the instrument has been set-up.

Basic Mode (Task BASIC)

This instrument will power-up in this mode the first time that it is used. To select **BASIC** from any other task, press the **TASK** key and select **BASIC** and press the **ENTER** key. **BASIC** mode is fully described in the **Getting Started**, section (see page 7).

Taking Measurements

Pressure Transmitter (P-I) Task

Select the P-I task from the task menu and connect the Unit Under Test (UUT) to the calibrator as shown below:

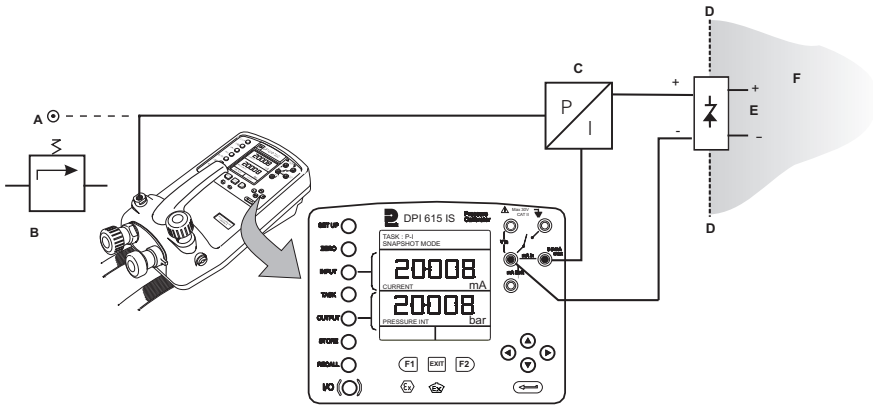

A - External pressure source (indicator instruments only) B - Pressure regulator
C - Pressure to current device D - Barrier E - External supply F - Safe Area

- If required, select the output units as described on page 10.
- If applicable, turn on Cal Mode and set-up test parameters as detailed on page 11.

Voltage Output Pressure Transmitter (P-V) Task

Select the P-V task from the task menu and connect the Unit Under Test (UUT) to the instrument as shown below:

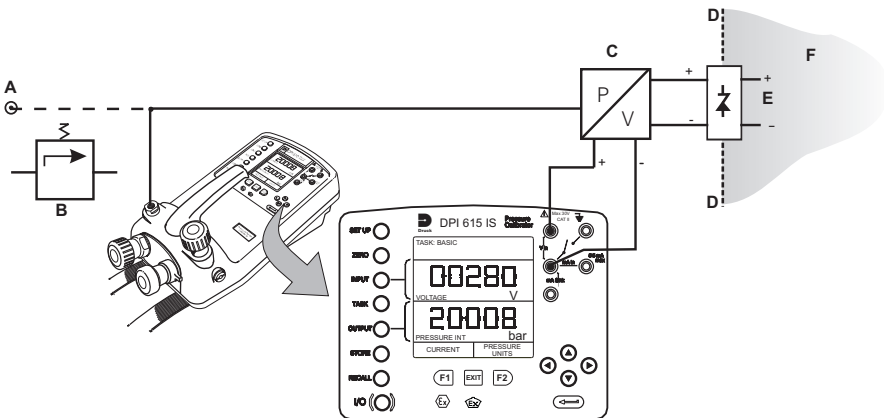

A - External pressure source (indicator instruments only) B - Pressure regulator
C - Pressure to voltage device D - Barrier E - External supply F - Safe Area

- If required, select the output units as described on page 10.
- If applicable, turn on Cal Mode and set-up test parameters as detailed on page 11.

Taking Measurements

Pressure Converter (Pressure to Pressure) Task

Select the P-P task from the task menu and connect the Unit Under Test (UUT) to the calibrator as shown below. Testing a converter requires one **pressure** to be applied to the unit under **test (UUT)** and another (**converter output**) to be measured. The additional measurement is provided by the external transducer option.

Method

- Connect the UUT to the instrument as shown below. Plug the external transducer into the instrument as shown below:

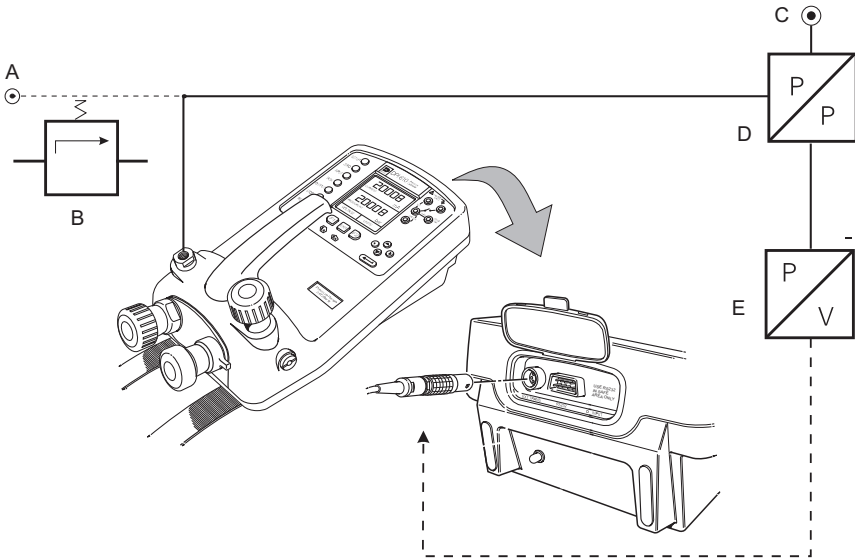

A - External pressure source (indicator instruments only) B - Pressure regulator
C - External pressure source D - Pressure to pressure device E - External transducer

- Press the TASK key and select the P-P task. Providing the external transducer has been calibrated and its parameters stored in the instrument, the display will show **External** pressure in the input window and calibrator **Output** pressure in the output window. If an error message "NO SENSOR OR CAL INVALID" is displayed, this indicates that the external transducer has not been entered and/or calibrated with the instrument. Refer to page 56 for details of adding an external transducer. **If an external transducer change is made, switch the calibrator off and then on to load new transducer data.**
- If required, select the input and output units as described on page 10.
- If applicable, turn on Cal Mode and set-up test parameters as detailed on page 11.

Taking Measurements

Current to Pressure Converter (I-P) Task

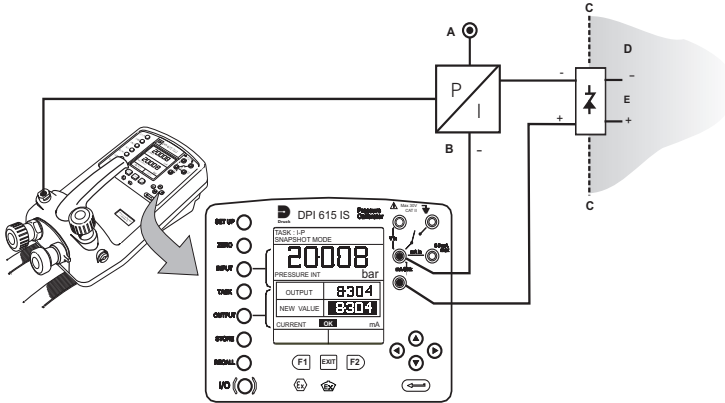

A - External pressure source B - Pressure to current device (24V) C - Barrier
 D - Safe area E - External supply

- Use the **up ▲** and **down ▼** cursor keys to adjust the loop current to the required value. Alternatively, press **ENTER** and use cursor keys to enter a finite value. Cursor keys can then be used to nudge the output either up or down. If required, change pressure units with **INPUT** key. A flashing **CHECK LOOP** message indicates either an open circuit supply loop (or no external supply).

Pressure Switch Test (P-SWITCH) Task

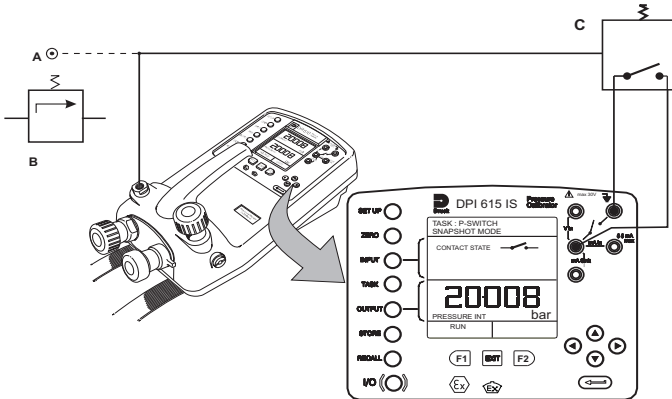

A - External pressure source B - Pressure regulator C - Pressure switch under test

- Contact state will be shown on display. When contacts close, buzzer sounds.
- To run switch test, close vent valve and press the **RUN (F1)** key.
- Using the hand-pump, increase the applied pressure to just below the switch operating point. Screw the volume adjuster in until the switch operates (the operating pressure of the switch is then written to the display).
- Reduce pressure until the switch releases (indicated by the switch symbol). The release pressure is then written to the display and the hysteresis displayed.

Taking Measurements

Pressure to Display (P-DISPLAY) Task

P-Display is a special application of Data Log. To use this mode, select Data Log from the Store Mode menu as detailed on page 36. Connect the UUT to the instrument as shown below and, if required, turn on and set-up Cal Mode (see page 11).

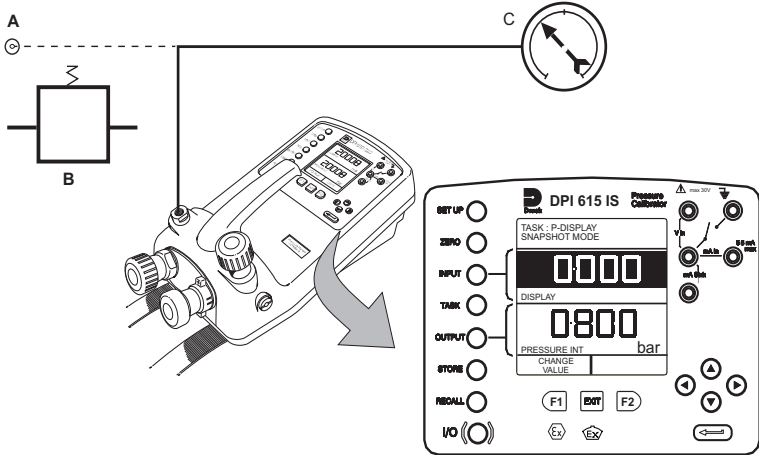

- A - External pressure source B - Pressure regulator C - Dial gauge under test
- Press **TASK** and select **P-DISPLAY**. If required, use **OUTPUT** key to change pressure units.
- Set-up a data log file as detailed on page 30.

Note: *TRIGGER* field, automatically set to **KEYPRESS**, cannot be changed.

- Apply a series of test pressures to the device under test. Enter displayed reading at each pressure and log each point:

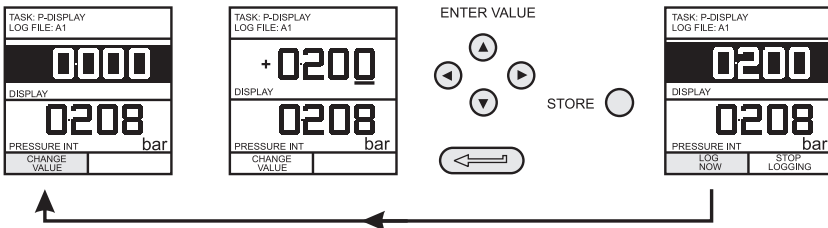

- After logging final test point, terminate as follows:

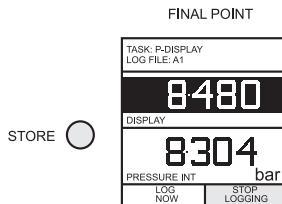

Taking Measurements

Leak Test (LEAK TEST) Task

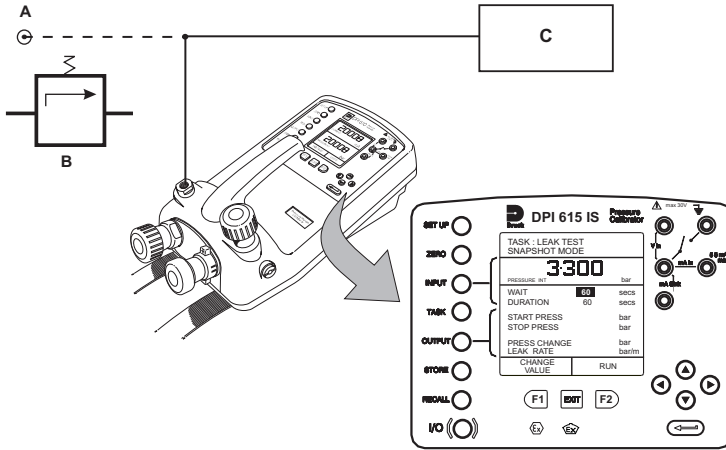

A - External pressure source B - Pressure regulator C - Device/system under test

- If required, use the **INPUT** key to change pressure units.
- Set-up the leak test **WAIT** and **DURATION** times to the required values as shown below. A minimum wait period of 3 minutes is recommended.

TASK : LEAK TEST SNAPSHOT MODE	
0:304	
PRESSURE INT	bar
WAIT	180 secs
DURATION	60 secs
START PRESS	bar
STOP PRESS	bar
PRESS CHANGE	bar
LEAK RATE	bar/m
CHANGE VALUE	RUN

SET WAIT TIME

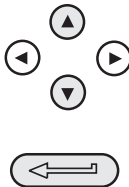

TASK : LEAK TEST SNAPSHOT MODE	
0:304	
PRESSURE INT	bar
WAIT	180 secs
DURATION	60 secs
START PRESS	bar
STOP PRESS	bar
PRESS CHANGE	bar
LEAK RATE	bar/m
CHANGE VALUE	RUN

SET DURATION

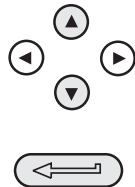

- Close the vent valve and pressurize the device/system to the required **LEAK TEST** pressure.
- Press the **RUN (F2)** key to start the leak test. When completed, the beeper sounds and the leak test results are written to the display.

Taking Measurements

Transmitter Simulator (TX SIM) Task

When used with an external voltage source (see page 24), provides a current output proportional to the calibrator's measured output pressure (indicated pressure on indicator only version). Select task **TX SIM**. Press **EXIT** to skip set-up screen if parameters are correct.

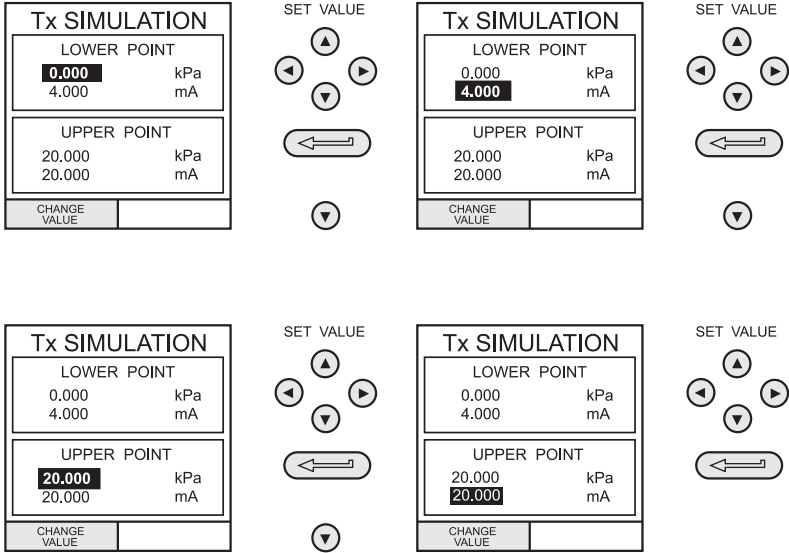

On completion of **Tx SIM** set-up, the display is configured as follows :

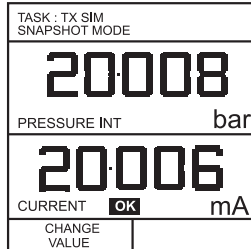

Connect an external power source to the output loop as detailed on page 24.

To subsequently change any of the **Tx SIM** scaling parameters, press **CHANGE VALUE** key (F1) to obtain the TX Simulation set-up display.

To change the pressure units, press **INPUT** and select the required scale units. If the required scale units are not listed, press **SETUP**, select **SETTINGS** and proceed as detailed on page 37.

Taking Measurements

Relief Valve Test (REL VALVE) Task

To carry out a relief valve test, press **TASK** and select **REL VALVE**. Connect the output pressure port of the instrument to an external system as shown below:

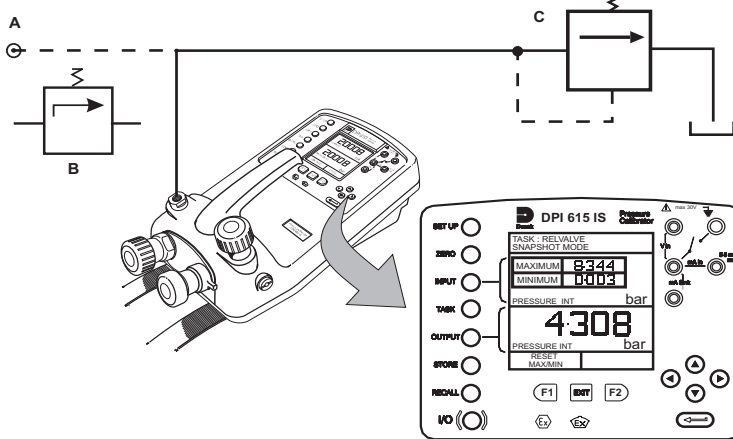

A - External pressure source (indicator only) B - Pressure regulator C - Relief valve under test

- To change the pressure units, if required, press **INPUT** and select the required units using the cursor keys.
- Close the vent valve and, using the hand-pump or external pressure supply, apply pressure to the relief valve under test.
- When the relief valve operates, the maximum recorded pressure indicates the operating point of the valve.
- Record the test results.

Note: The **STORE** key can be used for this purpose. Use right cursor key initially, followed by up/down keys to enter Snapshot text.

- Open vent valve to release test pressure.

Note: If using external pressure supply, isolate supply before opening the vent valve.

General

Advanced task allows the user to configure the instrument to monitor one of a number of different input measurements and outputs (sources). Additionally, five process functions, **Tare**, **Max/Min**, **Filter**, **Flow** and **% Span** can be applied to the input functions.

Select Input

To select an input channel, select **ADVANCED** task from the task menu. The display shows the list of the input selections and, if available, the **PROCESS** soft box (F1) and the **UNITS** soft box (F2).

The following procedure shows the method of input channel selection and the method of changing units:

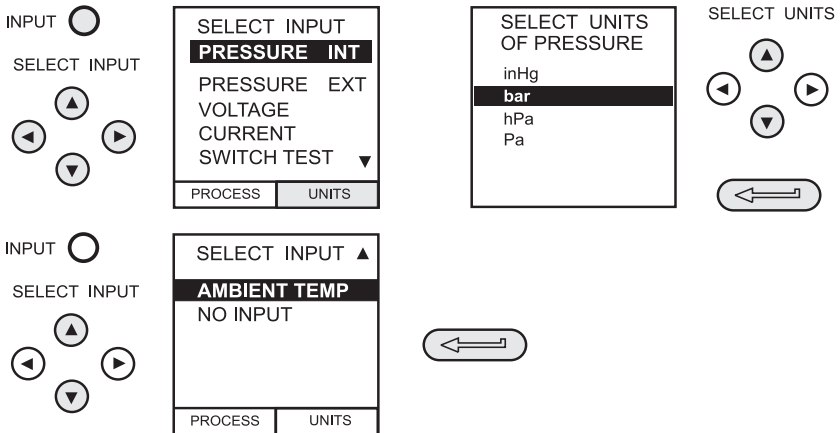

Note: Left/right arrow keys function as page up/down keys.

Refer to pages 20 to 23 for details of process functions.

Ambient Temperature Measurement

To set-up the instrument to read ambient temperature, proceed as follows:

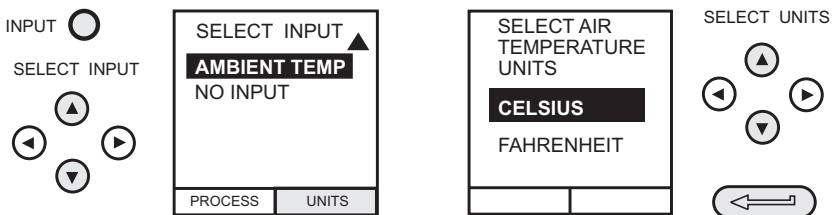

Note: Ensure that the temperature reading has stabilised.

Process Functions

If required, the following process functions are available on the input display but **only** in **ADVANCED** task. If the instrument is in any other mode i.e. BASIC or any other task mode, the input and output displays must first be configured in **ADVANCED** task.

Note: *PROCESS functions are not available to the output channel.*

A summary of the process functions follows.

- Tare** Allows either the current display value or a manually entered value to be tared off display parameter reading.
- Max/Min** Displays running Max/Min and present display values simultaneously. Resettable via F1 key.
- Filter** Applies low pass filter function to displayed parameter. Filter characteristics (*Settling time and Band*) are user programmable.
- Flow** Applies square root function to displayed parameter.
- % Span** Converts displayed parameter reading to a percentage of span. Span definable via the F1 key.

Following selection of **ADVANCED** from the task menu, press the **INPUT** key. Use the **up** ▲ or **down** ▼ cursor keys to select the required input. Press the **PROCESS** (F1) key and use the **left** ◀ or **right** ▶ cursor keys to enable the process on/off:

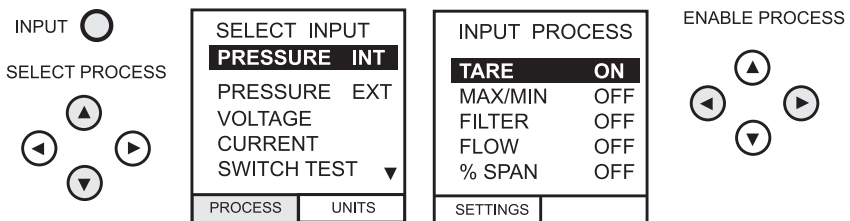

Press **ENTER** to switch the process ON with existing settings or F1 to change process settings (where applicable).

- Tare Process Function**

To set-up a Tare function, enable **TARE** from the process menu and press F1 to enter the Tare **SETTINGS** functions.

Disable **TARE** by entering process menu and turning the function **OFF**.

Note: Last TARE setting is retained and will be applied when function is next enabled.

Tare Current input Reading To tare-off the current display reading, proceed as follows:

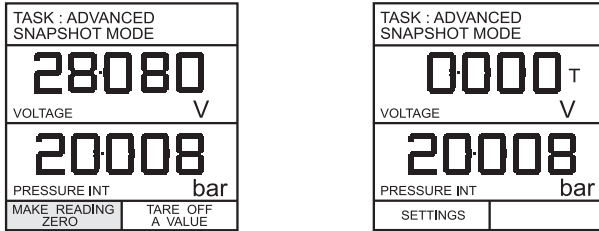

Tare Off An Entered Value To tare-off an entered value current, proceed as follows:

Note: Display shows the last entered Tare Value.

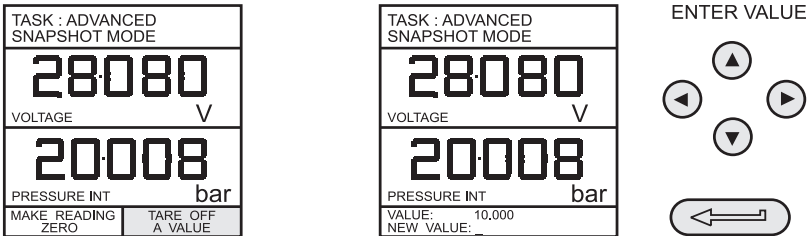

- Min/Max Process Function**

To set-up an input display to show min/max and present input reading, enable MIN/MAX from the process menu and press F1 (SETTINGS) to provide **RESET** function. The display now shows the max/min values as follows:

TASK : ADVANCED SNAPSHOT MODE	
MAXIMUM	8304
PRESENT	4308
MINIMUM	0003
VOLTAGE V	
8304	
PRESSURE INT bar	
RESET	
MAX/MIN	

Reset Max/Min display at any time by pressing the F1 key.

To quit max/min, press **INPUT**, select **MAX/MIN** from process menu and switch the function off.

- Filter Process Function**

To apply the low pass filter to a selected input, enable **FILTER** from the process menu and press F1 (SETTINGS) to provide access to the filter parameters. Two settings are required, *Time to Settle* and *Band*.

To examine the current filter settings and exit without change, press the **EXIT** key.

The set-up procedure is as follows:

SET FILTER	
TIME TO SETTLE TIME = 2 Seconds	
BAND = MAX AMPLITUDE OF NOISE TO BE FILTERED. CHANGES GREATER THAN BAND BYPASS THE FILTER	
BAND = 1.5 % FS	
CHANGE VALUE	

SELECT VALUE

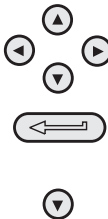

SET FILTER	
TIME TO SETTLE TIME = 2 Seconds	
BAND = MAX AMPLITUDE OF NOISE TO BE FILTERED. CHANGES GREATER THAN BAND BYPASS THE FILTER	
BAND = 1.5 % FS	
CHANGE VALUE	

SELECT VALUE

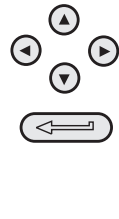

• **Flow Function**

To apply the flow function to a selected input, enable FLOW from the process menu and press **ENTER**. The square root symbol is displayed beside the input value to indicate that the **FLOW** function is active:

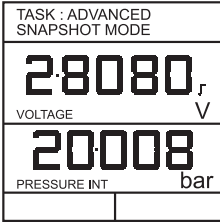

To cancel **FLOW**, press **INPUT** and turn function OFF at the process menu.

• **% Span**

To convert a selected input display from a numerical value to a percentage of full-scale reading, enable **SPAN** from the process menu and press F1 (SETTINGS) to provide access to the span definition parameters. Two span definitions are required, **Zero** and **Full Scale**.

To leave span at current setting, press **EXIT**.

To define zero and full-scale settings, proceed as follows.

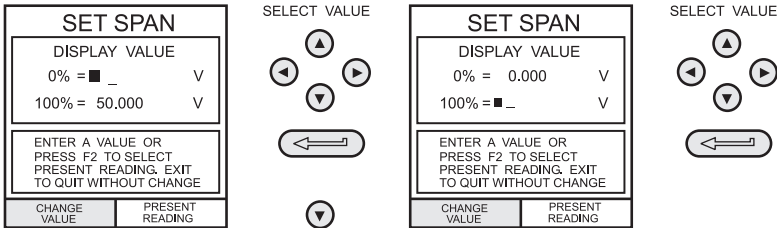

To cancel **% SPAN**, press **INPUT** and turn function OFF at the process menu.

Select Output

To display an output channel, select **ADVANCED** mode from the task menu. The display shows the list of output selections and, if available, the **UNITS** soft box (F2).

The following procedure shows the method of output channel selection from two pages of options. The second page can be obtained directly from the first by pressing the **right** cursor key:

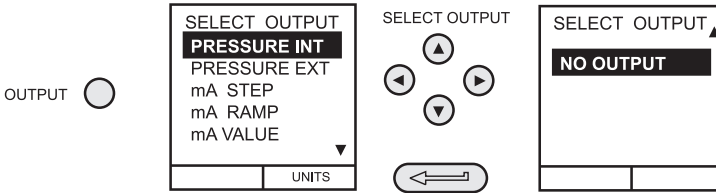

Note: Left/right arrow keys function as page up/down keys.

To change the output units (pressure channels only), select the channel with the cursor keys and press F2 before pressing **ENTER**.

Electrical Outputs (Loop Power)

All the electrical outputs, the output loop must be powered from an external supply (current sinking).

External connections to the front panel of the instrument are shown below.

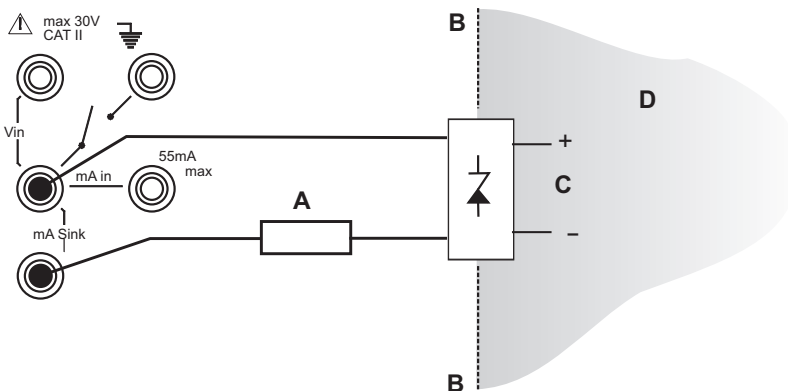

Current Sinking

- A Load
- B Barrier
- C (External supply 30 V dc maximum)
- D Safe area

mA Step

To select one of the electrical output programs, press the **OUTPUT** key and proceed as follows:

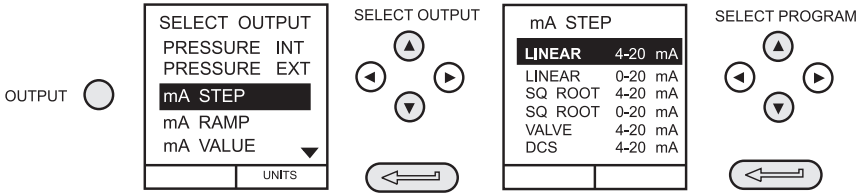

On selection of (e.g.) Linear, the output display window changes to show the selected program of output currents:

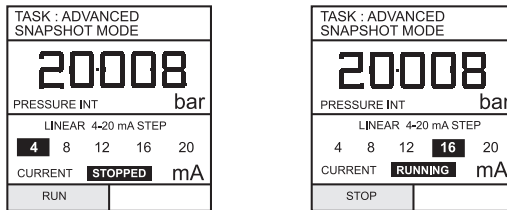

- Connect an external power source as shown on page 24.
- Press **RUN** (F1) to run program. A flashing status display **CHECK LOOP** indicates a fault in the external loop i.e. supply fault or open circuit.

Note: The dwell time at each step is approximately 10 seconds.

- Press **STOP** (F1) when running to stop at any point. Press **RUN** (F1) to resume.

mA Ramp

Press the **OUTPUT** key and select **mA Ramp** as shown previously in mA Step.

- Define ramp required by entering **START** and **END** current values as shown below:

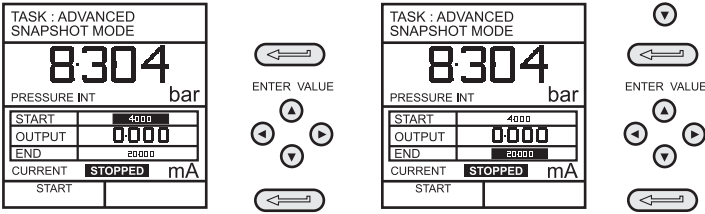

- Connect an external power source as shown on page 24.
- Press **START** (F1) to run the program. A status display **CHECK LOOP** indicates a fault in the external loop i.e. supply fault or open circuit.
Note: The ramp cycle (min to max or max to min), is approximately 60 seconds.

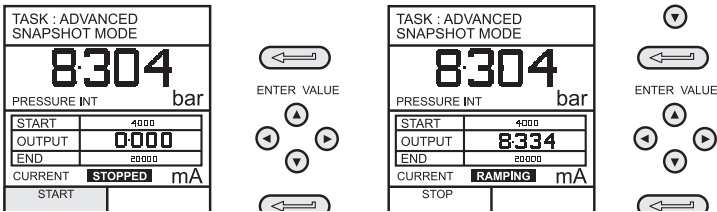

- Press **STOP** (F1) when running to stop at any point. Press **CONTINUE** (F1) to resume from point of pause or **RESET** (F2) to return to start point.

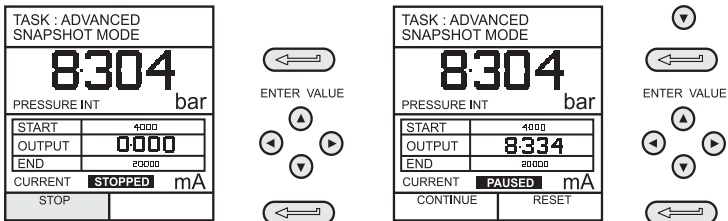

mA Value

Press the **OUTPUT** key and select **mA Value** from the output menu. The procedure is shown below:

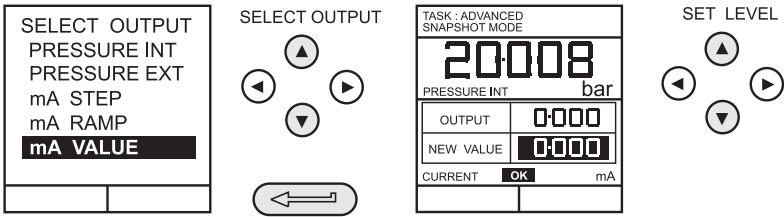

- Connect an external power source as shown on page 24.
- Use **up ▲** and **down ▼** cursor keys to adjust output current level. While the loop is made, a status display indicates **OK**. A status display **CHECK LOOP** indicates a fault in the external loop i.e. supply fault or open circuit.

Define New Task

To define a new task, proceed as follows.

- Select **ADVANCED** from **TASK** menu.
- Using the **INPUT** key, select the required input for the input display and set-up any process functions required.
- Using the **OUTPUT** key, select the required output for the output display.
- Press **TASK** and select **free**. Enter new task name as follows:

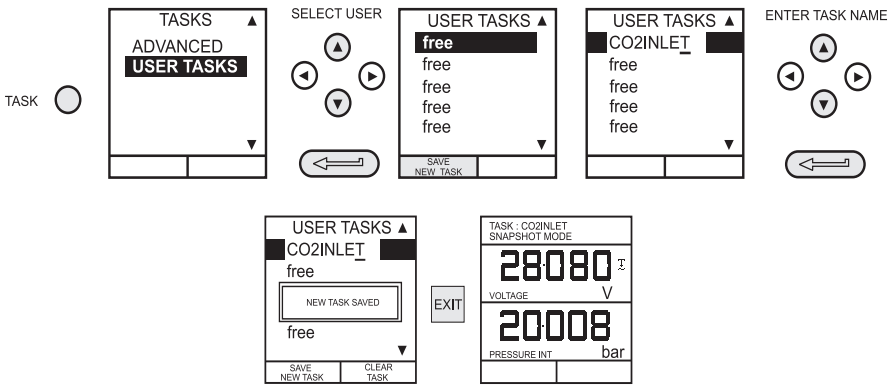

On completion of the this procedure, the display reverts to newly set-up task as shown.

Clear Task

To clear a user defined task, select **TASK** and proceed as follows:

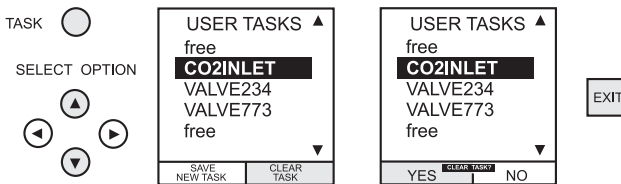

Saving Display or Data Log

In Store Mode three memory operations can be set-up: **None**, **Snapshot** and **Datalog**. Refer to **Using SETUP** for details.

Store Operations (Screen Snapshots)

To store any display (menu displays excepted), press the **STORE** key. This saves the current display to the next available location. Supporting text (10 characters) may be appended. Twenty memory locations are available on a cyclic buffer. When all 20 have been used, store operations overwrite existing locations, starting at *Location 1*.

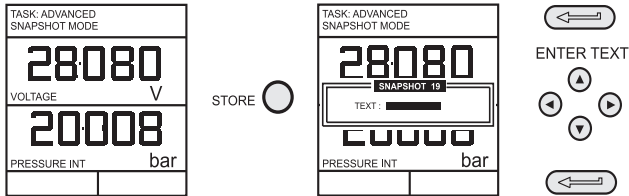

Recalling Stored Data (Screen Snapshots)

To recall a previously stored display, press the **RECALL** key. This recalls the last display saved. Press the **left** ◀ or **right** ▶ cursor keys to recall the previous or next locations respectively. To exit **RECALL**, press the **EXIT** key.

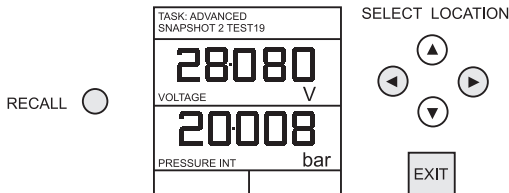

Data Log Operations

Data Log is a special application of store mode which enables the calibrator to either automatically log displays at preset time intervals or to manually log a display on operation of the **STORE** key. Logged data is written to a user specified file.

To set-up a Data Log file, proceed as follows.

- Select a task, other than **BASIC**. If using **ADVANCED**, set-up the required output parameters.
- Use **SETUP** to select Data Log from the Store Mode Menu (See page 36).

Auto Log (Timer)

Press **STORE** and set-up the Data Log file parameters as shown below. Use **CHANGE VALUE** (F1) followed by cursor keys to set field values. For Auto Log, set-up **TRIGGER** field to **PERIODIC**.

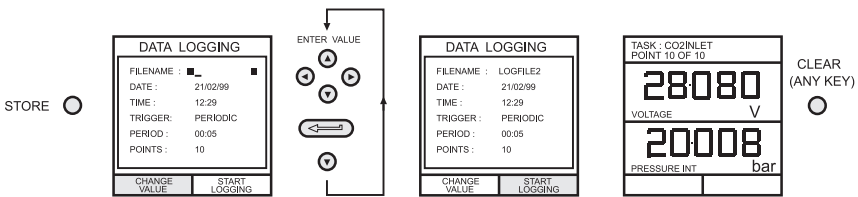

Manual Logging

Enter the file details as shown above and select **KEYPRESS** for **TRIGGER** field. Screen reverts to displayed parameters showing set-up file as shown below:

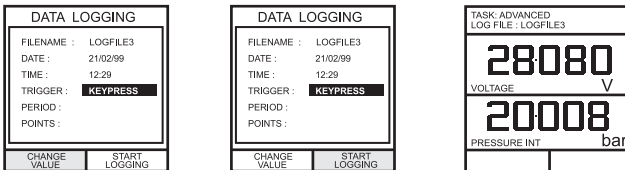

- Use a combination of **STORE** and **LOG NOW** (F1) to log events as follows.

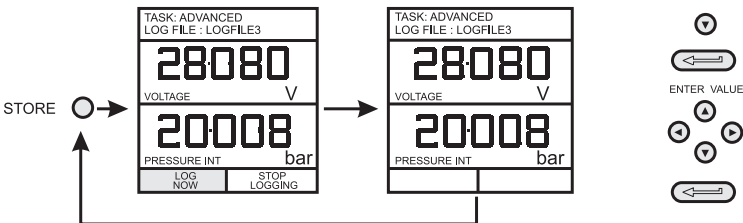

Recall Data Log Files

To recall a Data Log file to the display, ensure that **DATA LOG** is selected from the **SETUP** menu and proceed as follows:

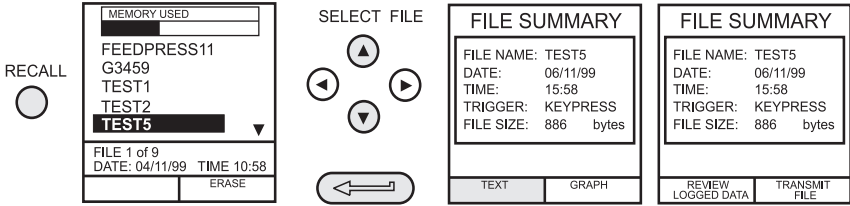

Data Log files can be displayed either as text (stored screens) or in graphical form. To display as text, proceed as follows from the File Summary menu. Select Auto Step to automatically review each screen at 1 second intervals or use the **left** ◀ and **right** ▶ cursor keys to manually review.

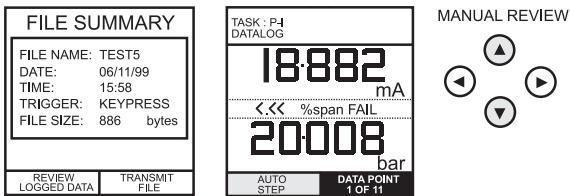

To display logged data in graphical form, on screen, proceed as follows from the File Summary menu:

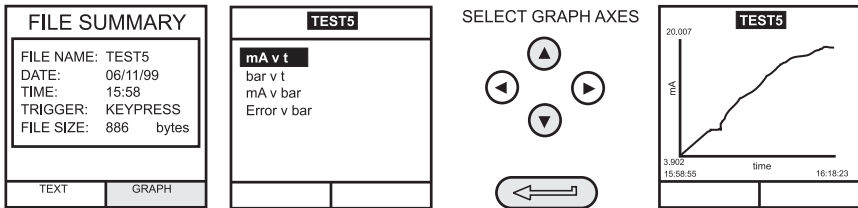

Uploading Data Log Files

WARNING
THE RS232 INTERFACE MUST ONLY BE USED IN A SAFE AREA

Connect the RS232 socket of the instrument into either the COM1 or COM2 port of the PC. Ensure that the RS232 parameters set in the PC match those of the instrument. The RS232 parameters of the instrument can be checked as detailed on page 38. Set up a file on the PC to receive the data, (e.g.) in the *Windows® Terminal* program.

To upload a file, proceed as follows. Appendix 1 gives details of a typical uploaded data log file.

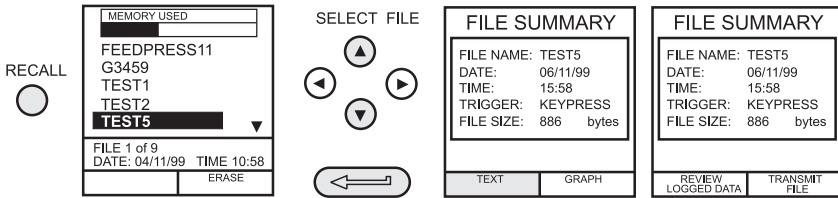

Delete Datalog and Procedure Files

To delete a Data Log file, or a procedure file (DPI 615 instruments only), proceed as follows. Alternatively, to delete all logged files simultaneously, select **ERASE ALL FILES** (F2) at the erase screen.

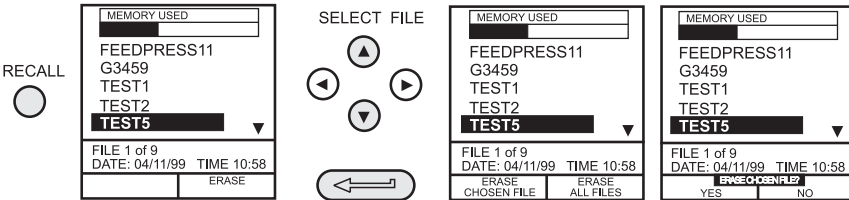

Downloading Procedure Files (DPI 615 instruments only)

WARNING

THE RS232 INTERFACE MUST ONLY BE USED IN A SAFE AREA

Complete test procedures may be downloaded from a PC to the DPI 615 instrument via the RS232 port. A procedure consists of a number of Druck Universal Command Interface (DUCI) commands that are usually assembled by a linking management software application (e.g.) **Druck Intecal**.

Before downloading a procedure, the instrument must be in the REMOTE mode. To place the instrument into REMOTE mode, proceed as follows.

- Connect the instrument's RS232 port to a free COM port on a PC.
- Make sure that the COMMS parameters of the PC match those of the instrument (refer to page 38).
- Make sure that the instrument is not already running a procedure. If it is, quit the procedure.
- Download the procedure. Procedures are stored in the Data Log directory.

The following sequence shows a typical download sequence that starts with the instrument in LOCAL mode.

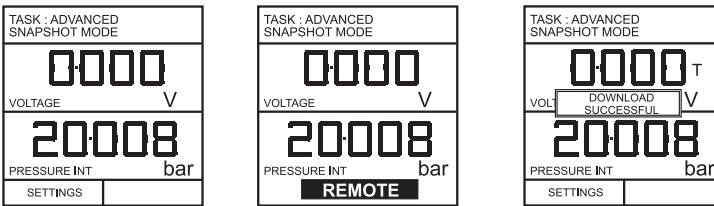

LOCAL MODE → REMOTE MODE → DOWNLOAD → LOCAL (AUTO)

After the procedure file has been downloaded, the instrument is usually returned to the LOCAL mode by the last command in the procedure file. If the instrument remains in REMOTE mode, switch it OFF and ON to reset it.

Running Procedure Files (DPI 615 instruments only)

To run a procedure, make sure that the instrument is set to Store mode, Data Log (see page 36), and proceed as follows:

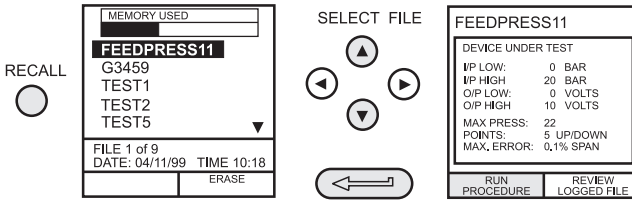

After selecting F1, proceed by entering the User ID and Serial Number and then select F1 (Continue) and follow the on-screen procedural instructions:

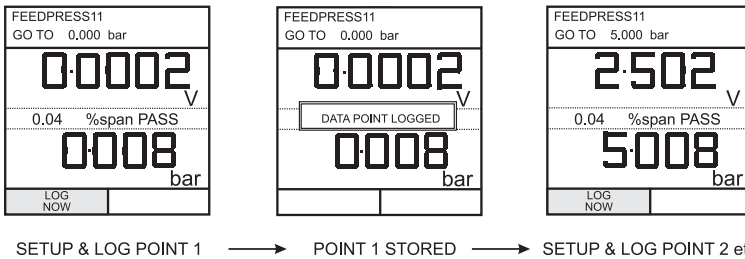

When the test procedure for a given UUT has been completed, the result of running the first test is stored as an AS FOUND file. This file cannot be overwritten. Any subsequent tests on the device are stored as an AS LEFT file that is overwritten each time the procedure on this device is run.

When recalling the results of a procedure, the choice of AS FOUND or AS LEFT is provided (refer to page 35).

Recalling Data Files (DPI 615 instruments only)

Data or results files generated by running procedures are stored in the instrument's data log directory. To recall a data file to the display, make sure that **DATA LOG** is selected from the **SETUP** menu and proceed as follows:

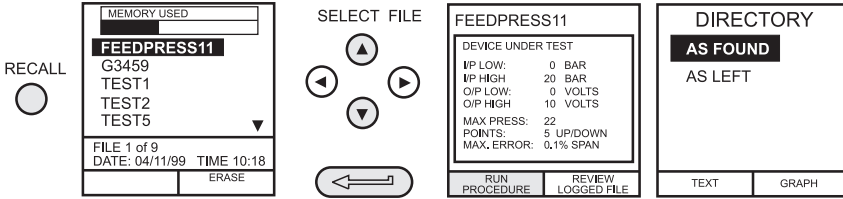

Use the cursor keys to select either the **AS FOUND** option or the **AS LEFT** option for display. **AS FOUND** is the result of the first run of a procedure and **AS LEFT** is the result of the last time the procedure was run.

Procedure data files can be displayed either as text (stored screens) or in graphical form. To display as text, select the **TEXT** option (F1) from the directory and proceed as follows from the File Summary menu. Select **AUTO STEP** (F1) to automatically review each screen at 1 second intervals or use the **left** ◀ or **right** ▶ cursor keys to manually review.

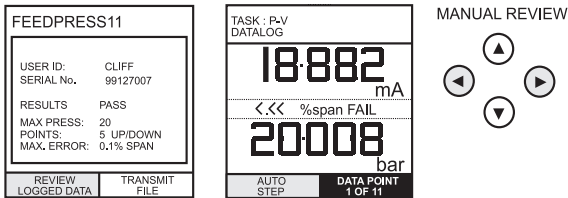

To transmit the selected logged data via the RS232 interface, connect the instrument to a free COM port on a compatible PC, ensure that the instrument's RS232 parameters match those of the PC.

To display logged data in graphical form, on screen, select **GRAPH** (F2) from the directory and proceed as follows:

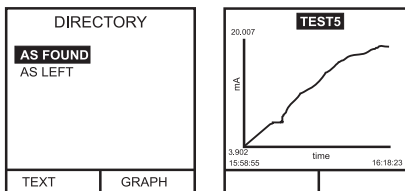

Using Setup

General

SETUP mode is available in all modes except **BASIC** and permits the changing of the following instrument parameters.

- Store Mode - None, Snapshot, Data Log.
- Contrast.
- Settings - Units, Language, RS232 parameters, Powerdown and Calibration Routines (Refer to page 41 for calibration details).
- Date and Time (Real Time Clock).

Store Mode

Select **STORE MODE** from the Set-up menu and select required mode as follows:

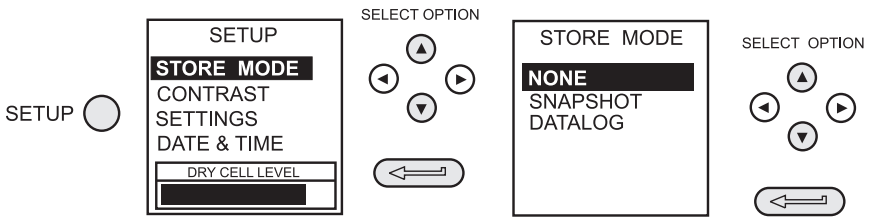

Contrast

Select **CONTRAST** from the Set-up menu and proceed as follows:

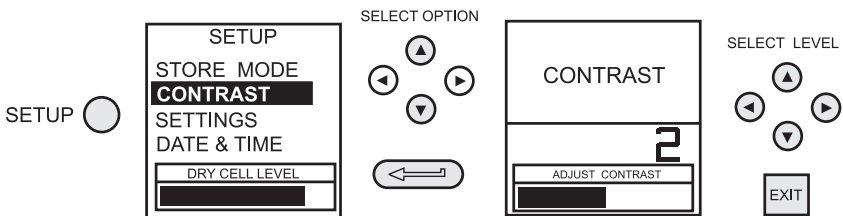

Using Setup

Settings - Select Setup Option

To select one of the **SETTINGS** options from the set-up menu, proceed as follows:

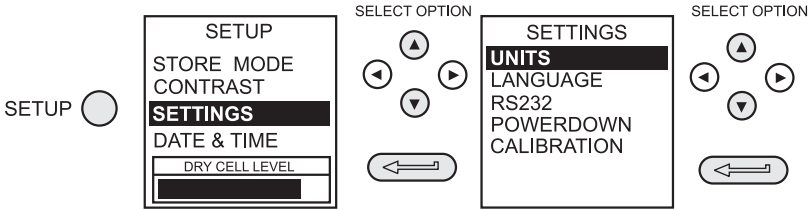

Units

Select **UNITS** from the **SETTINGS** menu and proceed as follows:

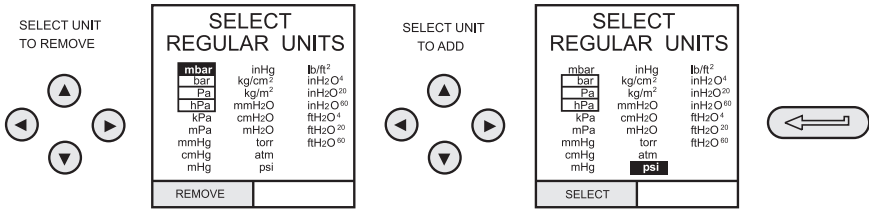

Define Special Units

Select **UNITS** from the **SETTINGS** menu and select **SPECIAL UNITS** and proceed as follows:

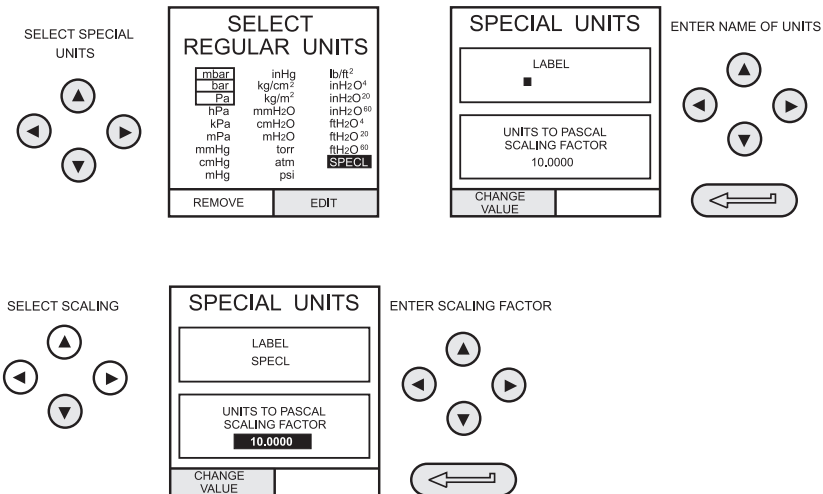

Using Setup

Language

Select the **LANGUAGE** version required from the **SETTINGS** menu and proceed as follows:

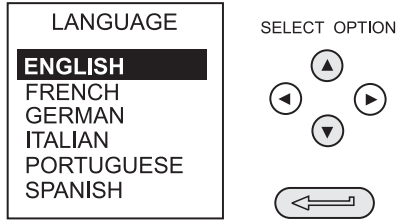

RS232

Select **RS232** from the **SETTINGS** menu and proceed as follows:

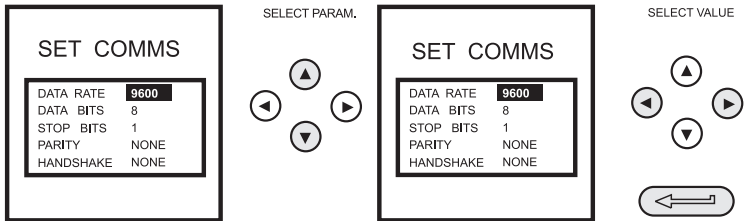

Note: Communications default settings are shown above.

If a communications problem occurs at a particular baud rate, change the baud rate on the instrument and PC to a lower rate.

Using Setup

Powerdown

Select **POWERDOWN** from the **SETTINGS** menu and proceed as follows:

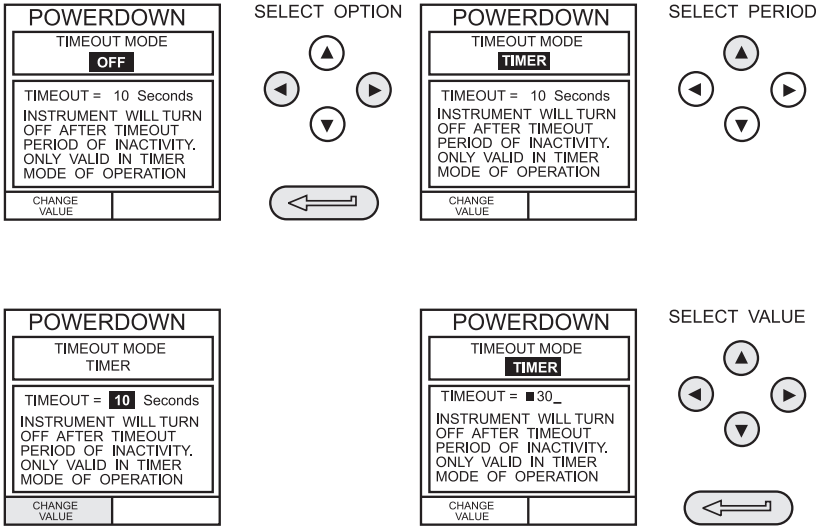

If selected to **TIMER** mode, following a period of inactivity, the instrument automatically powers off after the preset **TIMER** period.

If selected **OFF**, auto power off is inhibited and once switched on, the instrument remains **ON** until it is manually switched **OFF**.

Calibration

Refer to page 41 for a full description of the calibration procedures.

Using Setup

Date and Time (Real Time Clock)

Date Format

To set-up the real time clock, select **DATE & TIME** from the set-up menu and, using the ► key, set the required date format:

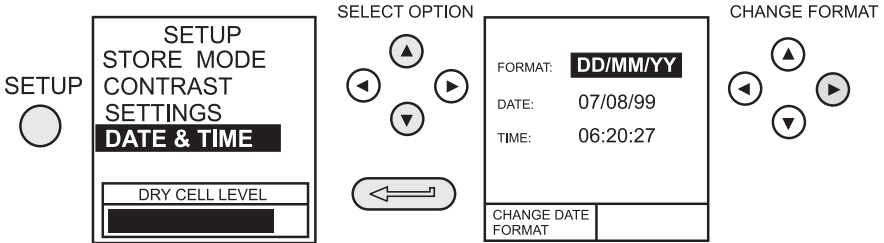

Set Date

Select **DATE** from the **DATE & TIME** menu and, using the cursor keys, change the date as shown below. The **up ▲** and **down ▼** keys change the numerical value of the selected digit (indicated by the underline cursor) and the **left ◀** and **right ▶** keys select the required digit position.

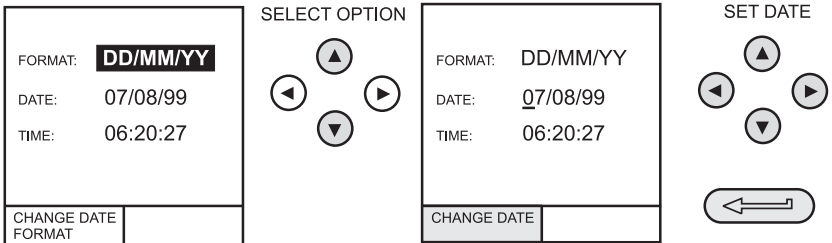

Set Time

Select **TIME** from the **DATE & TIME** menu and, using the cursor keys, change the time as shown below. The **up ▲** and **down ▼** keys change the numerical value of the selected digit (indicated by the underline cursor) and the **left ◀** and **right ▶** keys select the required digit position.

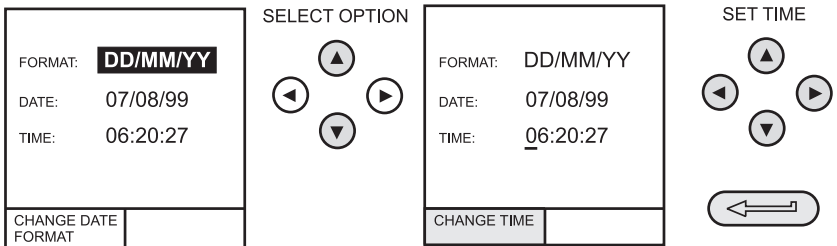

Calibration

General

The instrument is supplied by the manufacturer, complete with calibration certificate(s). A calibration period of 12 months is recommended. The actual calibration interval depends on instrument usage and the total measurement uncertainty acceptable for the specified application.

The DPI 610 IS and DPI 615 IS are very precise measuring instruments and the test equipment and conditions of test must be suitable for the type of work. A Class A compensated deadweight tester must be used. The calibration check and calibration adjustment should be carried out in a controlled environment by a calibration technician*.

The manufacturer offers a comprehensive and, if required, UKAS accredited calibration service.

* *A calibration technician must have the necessary technical knowledge, documentation, special test equipment and tools to carry out the calibration work on this equipment.*

Calibration Check

At the chosen calibration interval, the instrument readings should be compared with a known pressure standard.

The recommended method starts at 0, increasing in 20% steps to 100% full-scale and then decreasing in 20% steps to 0.

Note any deviations between the instrument and the pressure standard and consider traceability (accuracy to a National Standard).

If, after a calibration check, the results exceed the tolerance in the specification (or other suitable performance standard), carry out a calibration adjustment.

Calibration Adjustment

If the instrument is operating correctly, only zero and full-scale calibration will vary. Any excessive non-linearity or temperature effects indicate a fault. The instrument should be returned to a qualified service agent.

Guide to Calibration Procedures

- Use high quality **Repeatable and Linear** pressure sources and allow adequate thermal stabilization time before calibration (minimum 1 hour).
- Conduct the calibration in a temperature controlled and preferably, humidity controlled environment. Recommended temperature is **21°C, ±2°C (70°F, ±4°F)**.
- Use deadweight testers carefully and away from draughts.
- Review and become familiar with the whole calibration procedure before commencing the calibration process.
- The calibration routines cannot be accessed when the instrument is in **BASIC** mode. Use the **TASK** key to select another mode (e.g.) **ADVANCED** before accessing the **CALIBRATION** mode.

Calibration

Test Equipment

The calibration procedures require the following test equipment.

Test Equipment and Instrument Parameter/Range	Calibration Equipment Accuracy	Calibration Uncertainty
Digital Voltmeter - 5V input	±30 *ppm ±1 digit	±10 *ppm ±5µV
Digital Voltmeter - 30V input	±45 *ppm ±1 digit	±11 *ppm ± 110 µV
Digital milliammeter - 55mA input	±150 *ppm ±4 digit	±100 *ppm ± 1nA
Digital milliammeter - 24mA output	±150 *ppm ±4 digit	±160 *ppm ± 1nA
Precision thermometer - ambient temperature	±0.2°C	± 0.1°C ±1 digit
Deadweight tester - pressure internal/external	Class A deadweight	<0.025%

*ppm = parts per million

Table 1 Internal/External Pressure Transducer Verification

Nominal applied value as a % of ±full-scale	Permissible deviation
0% (10% for absolute ranges)	± 0.025% FS
20%	± 0.025% FS
40%	± 0.025% FS
60%	± 0.025% FS
80%	± 0.025% FS
100%	± 0.025% FS
80%	± 0.025% FS
60%	± 0.025% FS
40%	± 0.025% FS
20%	± 0.025% FS
0% (10% for absolute ranges)	± 0.025% FS

Calibration

Using the Calibration Menu

The calibration routines are selected from the Settings menu as detailed on page 37. Enter the calibration PIN code, initially set to **4321**, press  and the display shows the calibration menu.

PIN security

To prevent unauthorised access, it is recommended that the PIN code be changed as soon as possible.

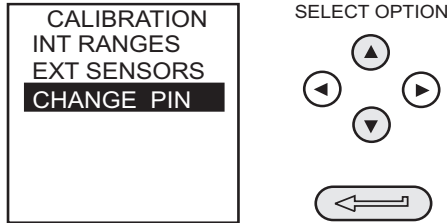

Change PIN

To change the PIN code, select **CHANGE PIN** from the calibration menu and proceed as follows:

Note: To set and verify a new PIN, the new PIN code must be entered twice.

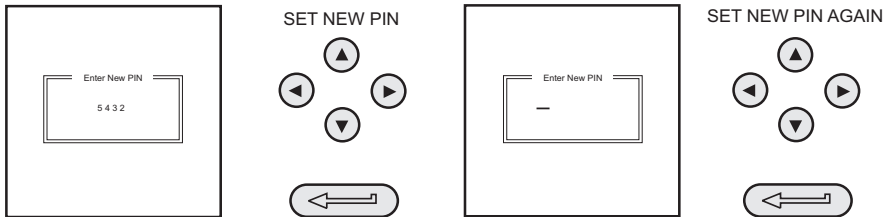

- If the second code entered differs from the first, the new PIN will not be set.



Calibrate Internal Ranges

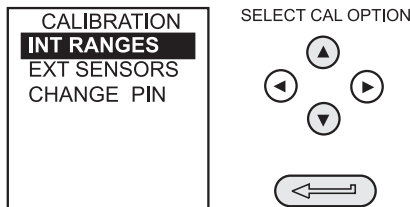

Select the **INT RANGES** from the menu as shown above and follow the calibration procedure on the display.

Calibration

Internal Pressure Range

Use the following procedure for calibrating the internal pressure range.

Note: If calibrating the hydraulic calibrator version, the calibrator must first be primed as detailed on pages 57 to 64.

- (1) Connect the outlet port of the instrument to a pressure standard.
- (2) Allow the instrument's temperature to stabilize for a minimum of 1 hour.
- (3) Switch the instrument on, enter **CALIBRATION** mode and select **INT RANGES** from the **CALIBRATION** menu and then **PRESSURE INT.**

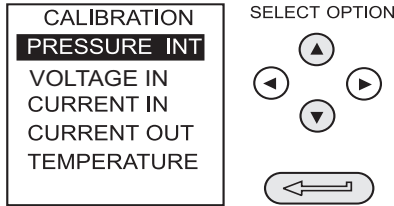

- (4) Apply zero pressure and store the zero point:

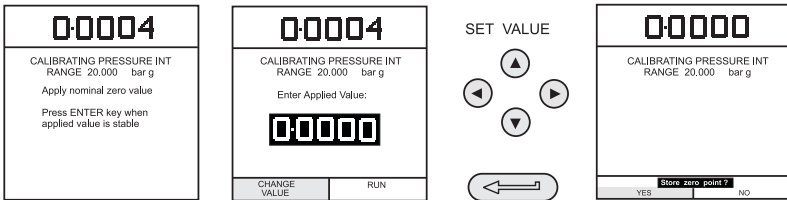

- (5) Close the vent valve, apply full-scale pressure and store the full-scale point:

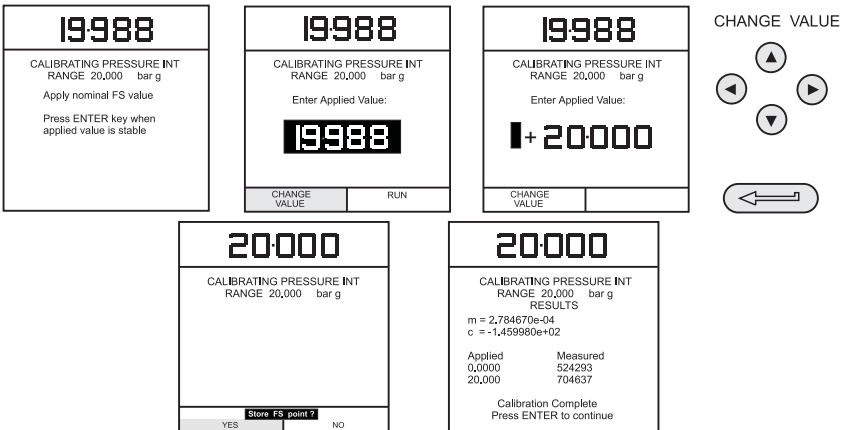

- (6) Press the **ENTER** key to accept the calibration. Press the **EXIT** key four times to quit **CALIBRATION** and **SETUP** modes.
- (7) Check calibration by applying test pressures in Table 1, page 42.

Calibration

Voltage Input Range (5 Volts)

Use the following procedure for calibrating the internal 5 Volt range.

- (1) Switch the instrument on, enter **CALIBRATION** mode and select **INT RANGES** from the **CALIBRATION** menu shown on page 43.
- (2) Select 5V range for calibration:

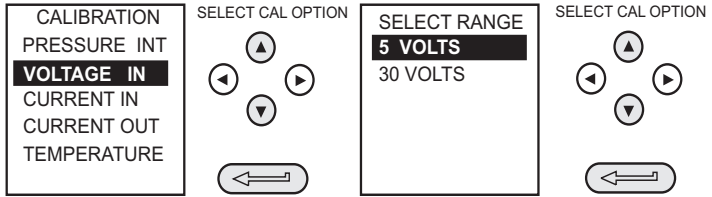

- (3) Link the voltage input terminals with a short lead and enter the zero point:

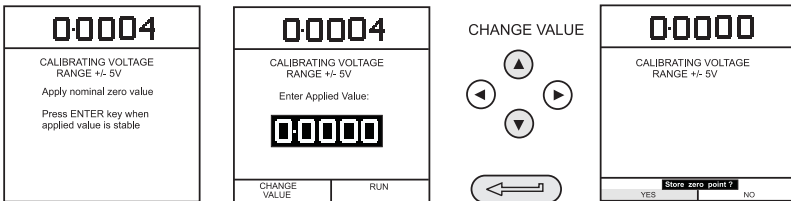

- (4) Remove the shorting link from the voltmeter terminals, connect the Vin terminals of the instrument to a variable voltage source and connect a digital voltmeter across the source:

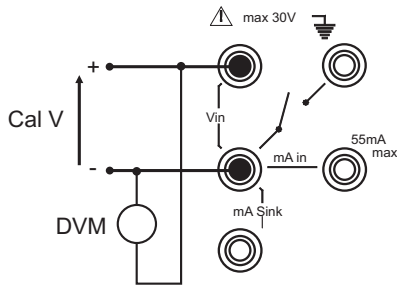

Calibration

- (5) Set the variable supply voltage to $5V \pm 0.1V$ and enter the measured full-scale voltage applied:

- (6) Press the **ENTER** key to accept the calibration. Press the **EXIT** key once to return to the calibration menu or four times to quit the **CALIBRATION** and **SETUP** modes.
- (7) Verify the instrument calibration by applying the test voltages given in Table 2 (page 48), to the voltmeter (after both voltage ranges have been calibrated).
- (8) Disconnect the calibration/test equipment.

Calibration

Voltage Input Range (30 Volts)

Use the following procedure for calibrating the internal 30 Volt range.

- (1) Switch the instrument on, enter **CALIBRATION** mode and select **INT RANGES** from the **CALIBRATION** menu as shown on page 43.
- (2) Select 30V range for calibration:

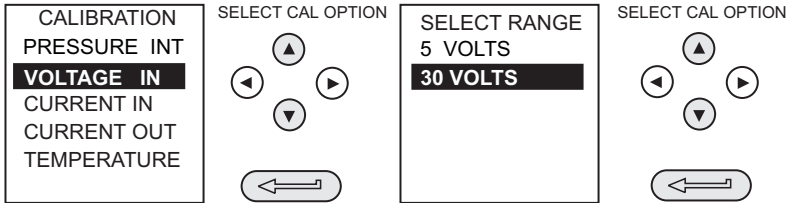

- (3) Link the voltage input terminals with a short lead and enter the zero point:

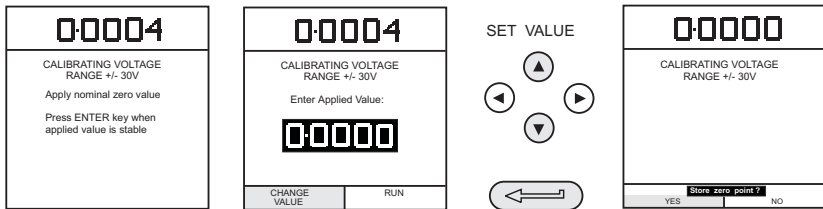

- (4) Remove the shorting link from the voltmeter terminals, connect the Vin terminals of the instrument to a variable voltage source and connect a digital voltmeter across the source:

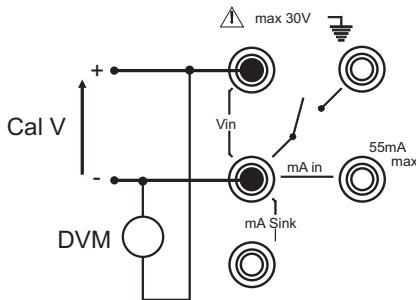

Calibration

- (5) Set the variable supply voltage to $30V \pm 0.1V$ and enter the measured full-scale voltage:

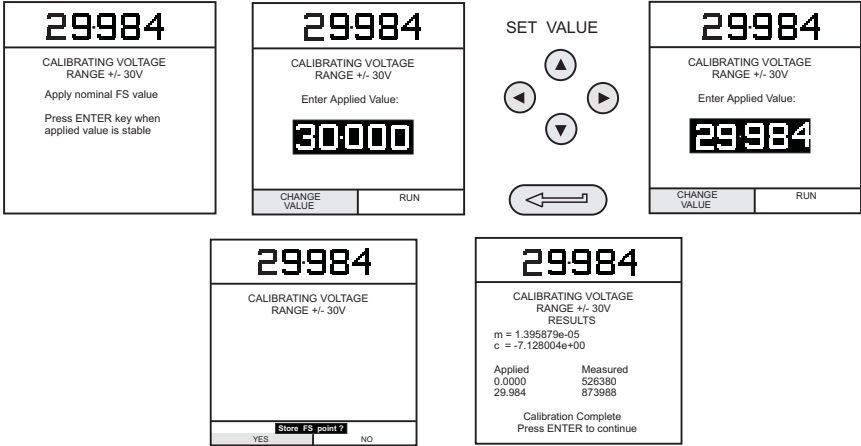

- (6) Press the **ENTER** key to accept the calibration. Press the **EXIT** key four times to quit the **CALIBRATION** and **SETUP** modes.
- (7) Verify the instrument calibration by applying the test voltages given in Table 2 to the voltmeter (after both voltage ranges have been calibrated).
- (8) Disconnect the calibration/test equipment.

Voltage Calibration 30V Range Verification Tolerances		Voltage Calibration 5V Range Verification Tolerances	
Applied Voltage	Permissible Deviation	Applied Voltage	Permissible Deviation
-30	$\pm 0.05\% \text{ rdg}, \pm 0.004\% \text{ FS}$	-5	$\pm 0.05\% \text{ rdg}, \pm 0.004\% \text{ FS}$
-24	$\pm 0.05\% \text{ rdg}, \pm 0.004\% \text{ FS}$	-4	$\pm 0.05\% \text{ rdg}, \pm 0.004\% \text{ FS}$
-18	$\pm 0.05\% \text{ rdg}, \pm 0.004\% \text{ FS}$	-3	$\pm 0.05\% \text{ rdg}, \pm 0.004\% \text{ FS}$
-12	$\pm 0.05\% \text{ rdg}, \pm 0.004\% \text{ FS}$	-2	$\pm 0.05\% \text{ rdg}, \pm 0.004\% \text{ FS}$
-6	$\pm 0.05\% \text{ rdg}, \pm 0.004\% \text{ FS}$	-1	$\pm 0.05\% \text{ rdg}, \pm 0.004\% \text{ FS}$
0	$\pm 0.05\% \text{ rdg}, \pm 0.004\% \text{ FS}$	0	$\pm 0.05\% \text{ rdg}, \pm 0.004\% \text{ FS}$
6	$\pm 0.05\% \text{ rdg}, \pm 0.004\% \text{ FS}$	1	$\pm 0.05\% \text{ rdg}, \pm 0.004\% \text{ FS}$
12	$\pm 0.05\% \text{ rdg}, \pm 0.004\% \text{ FS}$	2	$\pm 0.05\% \text{ rdg}, \pm 0.004\% \text{ FS}$
18	$\pm 0.05\% \text{ rdg}, \pm 0.004\% \text{ FS}$	3	$\pm 0.05\% \text{ rdg}, \pm 0.004\% \text{ FS}$
24	$\pm 0.05\% \text{ rdg}, \pm 0.004\% \text{ FS}$	4	$\pm 0.05\% \text{ rdg}, \pm 0.004\% \text{ FS}$
30	$\pm 0.05\% \text{ rdg}, \pm 0.004\% \text{ FS}$	5	$\pm 0.05\% \text{ rdg}, \pm 0.004\% \text{ FS}$

Table 2 Electrical Voltage Input Calibration Tolerances

Calibration

Current Input Range (55 mA)

Use the following procedure for calibrating the current input range.

- (1) Switch the instrument on, enter **CALIBRATION** mode and select **INT RANGES** from the **CALIBRATION** menu as shown on page 43.
- (2) Select **CURRENT IN** range for calibration:

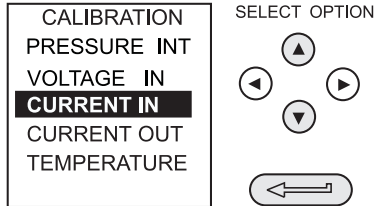

- (3) Open circuit the **mA in** terminals and enter the zero point:

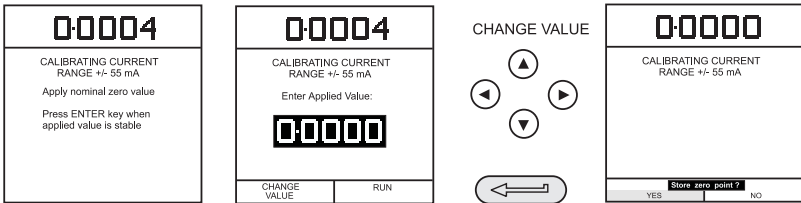

- (4) Connect the **mA in** terminals of the instrument to a variable current source and connect a digital milliammeter in series with the supply:

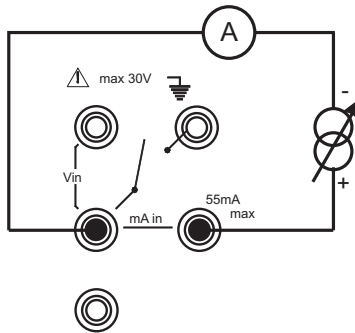

Calibration

- (5) Set the input current to $55 \pm 0.1\text{mA}$ and enter the measured full-scale input current:

54984
CALIBRATING CURRENT
RANGE +/- 55 mA
Apply nominal FS value
Press ENTER key when applied value is stable

54984
CALIBRATING CURRENT
RANGE +/- 55 mA
Enter Applied Value:
55.000

54984
CALIBRATING CURRENT
RANGE +/- 55 mA
Enter Applied Value:
+54944

CHANGE VALUE

CHANGE VALUE

CHANGE VALUE

54984
CALIBRATING CURRENT
RANGE +/- 55 mA
Store FS point?
YES NO

54984
CALIBRATING CURRENT
RANGE +/- 55 mA
RESULTS
m = 2,784670e-04
c = -1,459980e+02
Applied Measured
0,0000 524293
54,984 704637
Calibration Complete
Press ENTER to continue

- (6) Press the **ENTER** key to accept the calibration. Press the **EXIT** key four times to quit the **CALIBRATION** and **SETUP** modes.
- (7) Verify the instrument calibration by applying the test currents given in Table 3 to the milliammeter.
- (8) Disconnect the calibration/test equipment.

Current Calibration, 55mA Range Verification Tolerances	
Applied Current (mA)	Permissible Deviation
-55	$\pm 0.05\% \text{ rdg} \pm 0.004\% \text{ FS}$
-45	$\pm 0.05\% \text{ rdg} \pm 0.004\% \text{ FS}$
-35	$\pm 0.05\% \text{ rdg} \pm 0.004\% \text{ FS}$
-25	$\pm 0.05\% \text{ rdg} \pm 0.004\% \text{ FS}$
-15	$\pm 0.05\% \text{ rdg} \pm 0.004\% \text{ FS}$
-5	$\pm 0.05\% \text{ rdg} \pm 0.004\% \text{ FS}$
0	$\pm 0.05\% \text{ rdg} \pm 0.004\% \text{ FS}$
5	$\pm 0.05\% \text{ rdg} \pm 0.004\% \text{ FS}$
15	$\pm 0.05\% \text{ rdg} \pm 0.004\% \text{ FS}$
25	$\pm 0.05\% \text{ rdg} \pm 0.004\% \text{ FS}$
35	$\pm 0.05\% \text{ rdg} \pm 0.004\% \text{ FS}$
45	$\pm 0.05\% \text{ rdg} \pm 0.004\% \text{ FS}$
55	$\pm 0.05\% \text{ rdg} \pm 0.004\% \text{ FS}$

Table 3 Electrical Current Input Calibration Tolerances

Calibration

Current Output Range (24 mA)

Use the following procedure for calibrating the current output range.

- (1) Switch the instrument on, enter **CALIBRATION** mode and select **INT RANGES** from the **CALIBRATION** menu as shown on page 43.
- (2) Select **CURRENT OUT** range for calibration:

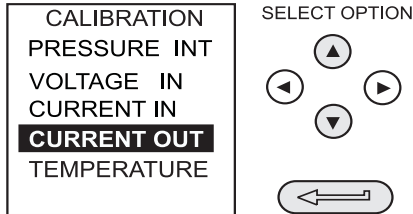

- (3) Connect a digital milliammeter to the instrument as shown below.

Note: This procedure requires an external supply.

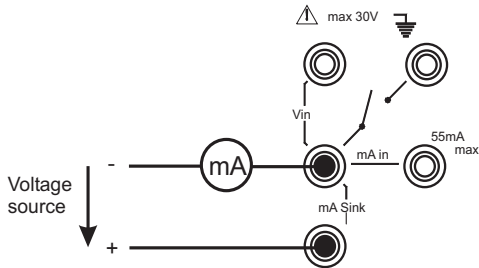

Calibration

- (4) Measure the 10% full-scale output current and enter the value measured on the external milliammeter:

- (5) Measure the 90% full-scale output current and enter the value measured on the external milliammeter

- (6) Press the **ENTER** key to accept the calibration. Press the **EXIT** key four times to quit the **CALIBRATION** and **SETUP** modes.
- (7) Verify the instrument's output current calibration by setting up the loop test currents as shown in Table 4 and checking the set values against the milliammeter standard.
- (8) Connect an external voltage source shown on page 51, press the **OUTPUT** key, select **mA Value**:

Calibration

- (9) Set the loop output current to 5 mA as shown below and check that the output current, measured by the milliammeter standard is within the limits given in Table 4.

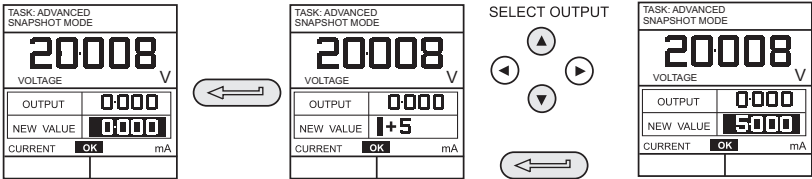

- (10) Repeat (9) for all output values given in Table 4.

Current Output Calibration, 24mA Range Verification Tolerances	
Applied Current (mA)	Permissible Deviation
0	$\pm 0.05\% \text{ rdg} \pm 0.01\% \text{ FS}$
5	$\pm 0.05\% \text{ rdg} \pm 0.01\% \text{ FS}$
10	$\pm 0.05\% \text{ rdg} \pm 0.01\% \text{ FS}$
15	$\pm 0.05\% \text{ rdg} \pm 0.01\% \text{ FS}$
20	$\pm 0.05\% \text{ rdg} \pm 0.01\% \text{ FS}$
24	$\pm 0.05\% \text{ rdg} \pm 0.01\% \text{ FS}$
20	$\pm 0.05\% \text{ rdg} \pm 0.01\% \text{ FS}$
15	$\pm 0.05\% \text{ rdg} \pm 0.01\% \text{ FS}$
10	$\pm 0.05\% \text{ rdg} \pm 0.01\% \text{ FS}$
5	$\pm 0.05\% \text{ rdg} \pm 0.01\% \text{ FS}$
0	$\pm 0.05\% \text{ rdg} \pm 0.01\% \text{ FS}$

Table 4 Electrical Current Output Calibration Tolerances

- (11) Disconnect the calibration/test equipment.

Calibration

Ambient Temperature Channel

Use the following procedure for calibrating the ambient temperature measurement channel.

- Switch the instrument on, enter the **CALIBRATION** mode and select **TEMPERATURE**:

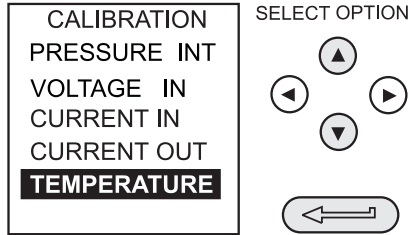

- Allow the instrument's temperature to stabilize in the calibration environment for at least one hour.
- Read the environmental temperature on a calibrated digital thermometer and enter the recorded value as shown below. Example shown for a measured ambient temperature of 21.5° Celsius.

Note: Only one temperature point is required.

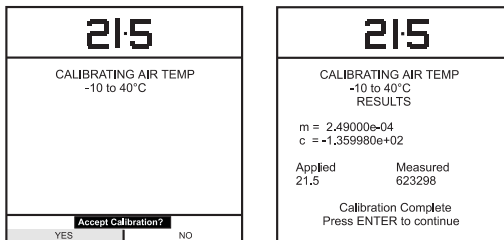
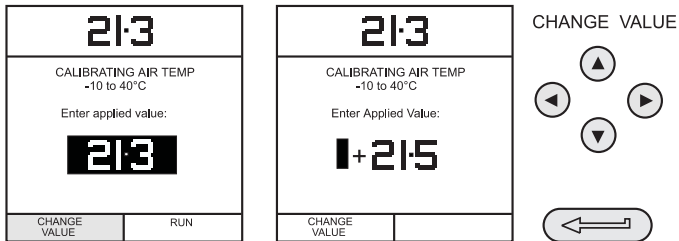

- Press the **ENTER** key to accept the calibration. Press the **EXIT** key once to return to the calibration menu or four times to quit the **CALIBRATION** and **SETUP** modes.

Calibration

Calibrate External Sensors

Use the following procedure for calibrating external pressure sensors.

- (1) Connect the required external transducer to the EXT TRANSDUCER socket located on the rear of the instrument.
- (2) Allow the instrument's temperature and the temperature of the external transducer to stabilize in the calibration environment for a minimum of 1 hour.
- (3) Switch the instrument on, enter **CALIBRATION** mode and select **EXT SENSORS** from the **CALIBRATION** menu:

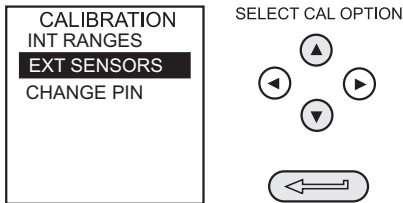

- (4) Select the transducer to be calibrated from the transducer menu using the cursor keys and press ENTER:

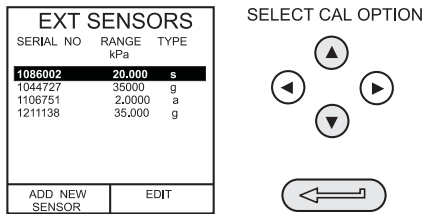

If the sensor to be calibrated is not in the directory, or no sensors are listed in the directory, press the **F1** key (ADD NEW SENSOR). This will place the sensor in the directory, allowing it to then be selected.

- (5) Connect the pressure standard to the inlet of the external transducer, apply the zero point pressure and store the zero point:

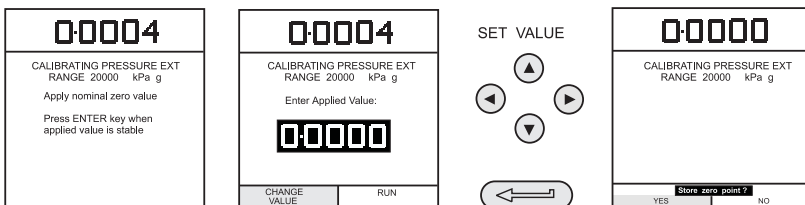

- (6) Apply the full-scale pressure to the external transducer and store the full-scale (FS) point.

The calibration sequence consists of the following screens:

- Screen 1: 19988. CALIBRATING PRESSURE EXT RANGE 20000 kPa g. Apply nominal FS value. Press ENTER key when applied value is stable.
- Screen 2: 19988. CALIBRATING PRESSURE EXT RANGE 20000 kPa g. Enter Applied Value: 19988.
- Screen 3: 19988. CALIBRATING PRESSURE EXT RANGE 20000 kPa g. Enter Applied Value: + 20000.
- Screen 4: 20000. CALIBRATING PRESSURE EXT RANGE 20000 kPa g. Store FS point? YES NO.
- Screen 5: 20000. CALIBRATING PRESSURE EXT RANGE 20000 kPa g. RESULTS. m = 2.784670e-04, c = -1.459960e+02. Applied: 0.0000, Measured: 524233. 20.000, 704637.
- Screen 6: 20000. Calibration Complete. Press ENTER to continue.

Control panel: CHANGE VALUE, four arrow keys (up, down, left, right), and a long key.

- (7) Release the applied pressure and disconnect the pressure reference. Press the **ENTER** key to accept the calibration. Press the **EXIT** key once to return to the calibration menu or four times to quit the **CALIBRATION** and **SETUP** modes.
- (8) Check the calibration of the external transducer by applying the test pressures as detailed in Table 1, page 42.

Add External Sensor

To add an external sensor to the directory of external sensors, proceed as follows:

- Connect the required external transducer to the EXT TRANSDUCER socket located on the rear of the instrument.

The 'EXT SENSORS' menu sequence is as follows:

- Screen 1: EXT SENSORS. SERIAL No. RANGE TYPE bar. ADD NEW SENSOR.
- Screen 2: EXT SENSORS. SERIAL No. RANGE TYPE bar. 1154738 20.000 g. ADD NEW SENSOR EDIT.
- Screen 3: EXT SENSORS. SERIAL No. RANGE TYPE bar. 1154738 20.000 g. REMOVE CHANGE DETAILS.

Digitally compensated transducers will be downloaded into the directory as soon as the F1 key is operated. Data for other types can be edited by selecting **EDIT** (F2). If the data cannot be edited a warning message (INVALID ACTION) is displayed.

Hydraulic Calibrator Versions

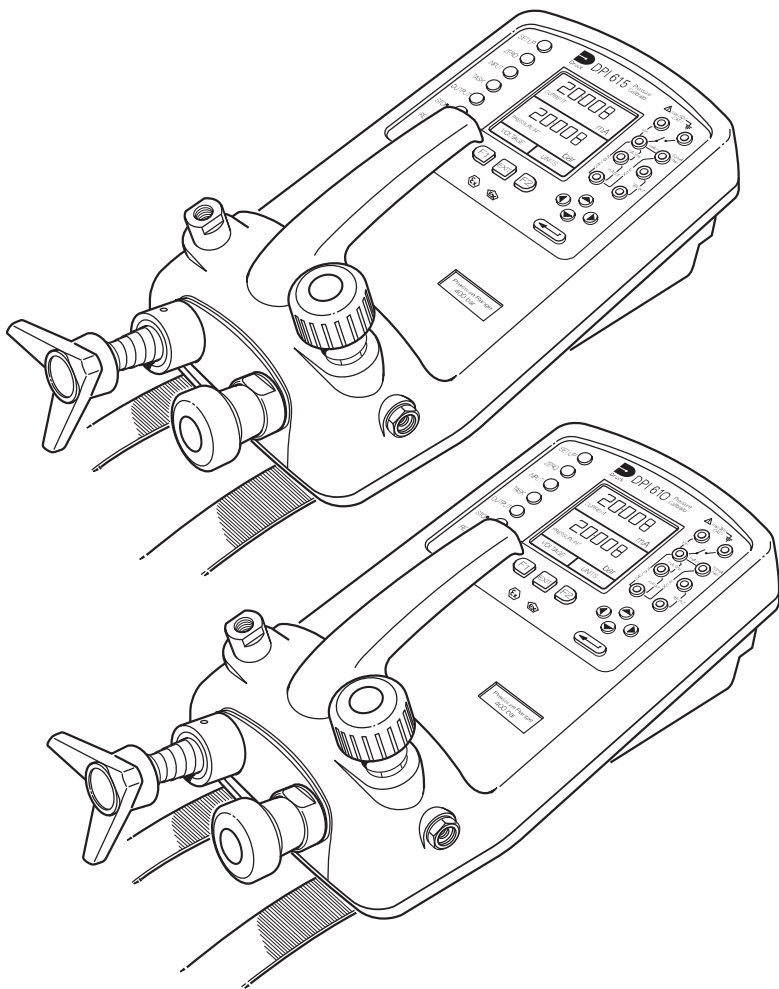

This page intentionally left blank

Introduction (Figure A1)

These versions of the DPI 610 and DPI 615 intrinsically safe calibrators provide manual generation of hydraulic pressure and consist of a screw-press with a priming pump and isolation valve.

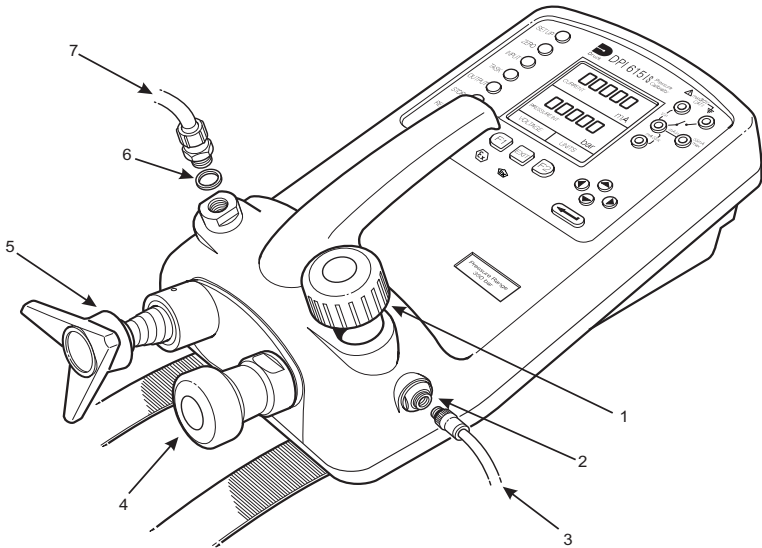

- 1 Isolation valve 2 Priming port 3 Bleed hose assembly 4 Priming pump
- 5 Screw-press 6 Bonded seal 7 UUT/system under test

Figure A1 - DPI 610/615 IS HC Connections

The internal hydraulic parts are brass, stainless steel, copper, nylon and fluorocarbon rubber (Viton). The hydraulic fluid can be either demineralized water or one of the hydraulic fluids listed below:

**Caution: Only use the recommended hydraulic fluids.
DO NOT mix hydraulic fluids.**

ISO 3448 Viscosity grade	Approx. SAE Viscosity Classification	Shell	Esso (Exxon)	Mobil
VG10	5W	Tellus R10	Nuto H10	Velocite No. 6
VG15		Tellus T15 Tellus V15	Nuto H15	
VG22		Tellus 22 Tellus R22	Nuto H22	DTE 22
VG32	10W	Tellus V32	Nuto H32	DTE Oil Light DTE 24
VG37		Tellus 37 Tellus R37 Tellus T37 Tellus V37		

Table A1 - Recommended Hydraulic Fluids

Safety Instructions

WARNING

HYDRAULIC FLUID IS INJURIOUS. OBSERVE RELEVANT HEALTH AND SAFETY PRECAUTIONS. USE APPROPRIATE PROTECTIVE BARRIERS AND EYE PROTECTION.

BEFORE APPLYING PRESSURE, EXAMINE ALL FITTINGS AND EQUIPMENT FOR DAMAGE AND ENSURE THAT ALL EQUIPMENT IS TO THE CORRECT PRESSURE RATING.

DO NOT EXCEED THE MAXIMUM WORKING PRESSURE OF THE INSTRUMENT (INDICATED ON START-UP SCREEN AT SWITCH-ON).

Caution: Observe absolute cleanliness when using the instrument. Severe damage can be caused if equipment connected to this instrument is contaminated. Connect only clean equipment to the instrument. To avoid any contamination, an external filter is recommended.

Preparation for Use (Figure A1)

- Use an appropriate seal and connect the bleed hose assembly (3) to the priming port.
- Make sure that the screw-press (5) is wound fully in (clockwise).
- Make sure that the isolation valve (1) is open (fully counter clockwise).
- Use a bonded seal (6) and connect the unit or system under test (7) to the pressure port.

WARNING

MAKE SURE THAT THE CONNECTING LINE TO THE EXTERNAL DEVICE OR SYSTEM IS CAPABLE OF WITHSTANDING THE LINE PRESSURE TO BE APPLIED.

Note: A bleed point must be provided on the external device.

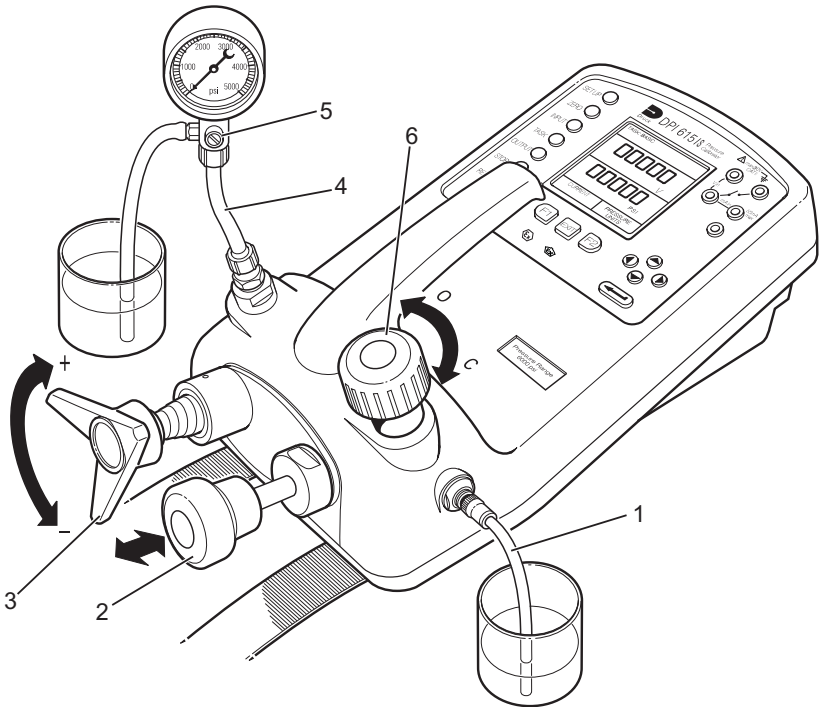

- | | | | | | |
|---|-----------------------|---|-----------------|---|-----------------|
| 1 | Bleed hose assembly | 2 | Priming pump | 3 | Screw-press |
| 4 | UUT/system under test | 5 | UUT bleed valve | 6 | Isolation valve |
| O | - Open | C | - Closed | | |

Figure A2 - Priming/Test Set-up

Bleeding the System (Figure A2)

Before any measurements can be made, the hydraulic system needs to be primed and bled free of air. During the following operations, prepare for fluid spillage and provide a suitable receptacle for collecting the spillage.

1. Prepare for use as detailed on page 62.
2. Fill a suitable container with clean hydraulic fluid and place the bleed hose assembly (1) connected to the priming port into the fluid.
3. Open the UUT bleed valve (5) and, if possible, fit a hose to the bleed point and locate the hose end in a container of the same hydraulic fluid.
4. Use the priming pump (2), to pump hydraulic fluid into the instrument and the connected system. Monitor the hydraulic fluid level, ensuring that the bleed hose assembly (1) stays below the fluid level and is not allowed to suck in air. Top-up hydraulic fluid level as necessary.

5. Continue use of the priming pump (2) until only hydraulic fluid and no air is expelled from the bleed point.
6. Close the UUT bleed valve (5) when the priming pump (2) is at the bottom of its stroke (fully pushed in) and slowly wind out the screw-press (3) to its fullest extent to draw in further hydraulic fluid (approx. 7cc or 0.43 in³).
7. Switch the instrument **ON** and, still using the priming pump (2), pressurize the system to approximately 2 bar (30 psi).
8. Close the isolation valve (6) disconnect the bleed hose assembly (1) from the priming port.

Operation

To obtain a pressure reading, proceed as follows.

1. Switch the instrument **ON** and select the required **TASK**.
2. Rotate the screw-press clockwise to increase the applied pressure.

Note: *When hydraulic fluid is compressed and flows through a restriction, there is an increase in temperature that affects the pressure. Allow sufficient time for this pressure reading to stabilize before recording or logging a reading.*

3. After testing, reduce the pressure in the system to zero by turning the screw-press counter clockwise. Before disconnecting the UUT, open the isolation valve.
4. Remove the connection to the UUT and fit a blanking plug into the instrument's pressure port. Clean any spilt fluid off the instrument case.

Draining the Hydraulic Fluid (Figure A3)

To drain the hydraulic fluid from the instrument, proceed as follows:

1. Turn the isolation valve (4) fully counter clockwise. Turn the instrument onto the left hand side (pressure port nearest to the work bench). Place receptacle below the pressure port to collect hydraulic fluid.
2. Drain the system by slowly winding in the screw-press (3) and then depressing the priming pump (2) plunger to expel any fluid remaining in the instrument.
3. If necessary, apply an air line to the priming port to clear any remaining fluid out of the instrument.

Flushing - Replenishing or Changing the Hydraulic Fluid (Figure A3)

If necessary, to remove any contaminants, flush out the hydraulic system as follows.

- a. Connect the bleed hose assembly (1) to the priming port and a bleed hose to the pressure port as shown below:

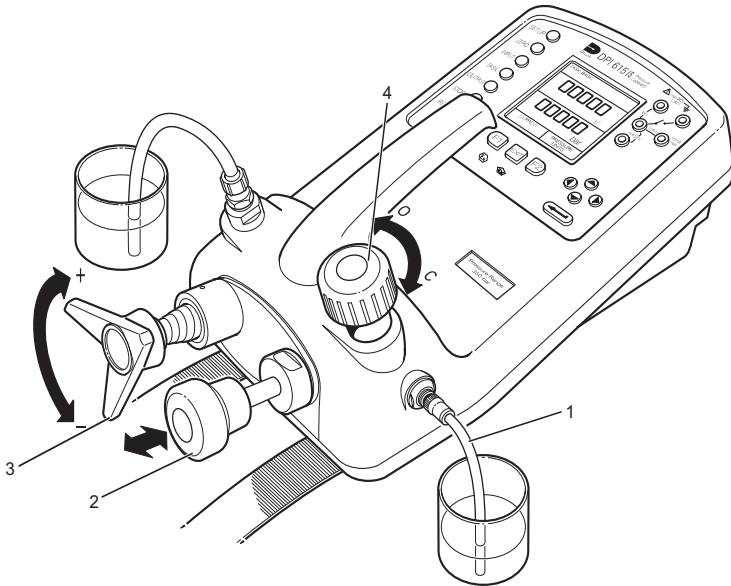

- | | | | |
|-----------------------|----------------|---------------|-------------------|
| 1 Bleed hose assembly | 2 Priming pump | 3 Screw-press | 4 Isolation valve |
| O - Open | C - Closed | | |

Figure A3 - Flushing/Filling Connections

- b. Fill the priming fluid container with clean hydraulic fluid of the required type. Use the priming pump (2), to pump fresh hydraulic fluid through the system until clean hydraulic fluid, free of air bubbles, emerges into the container at the output port. Discard the contaminated fluid expelled during this process.
- c. Remove the bleed hose assembly (1) located to the output port and, to prevent the ingress of any contaminant, fit a blanking plug in its place.
- d. Close the isolation valve (4) and remove the bleed hose assembly (1) from the priming inlet.
- e. Clean off any surplus oil that may have spilled onto the instrument casing.

The instrument is now ready for operation or storage. If storing, apply a label detailing the type of hydraulic fluid contained in the instrument. **For long term storage, it is recommended that the instrument be drained and stored empty.**

This page intentionally left blank

Appendix 1

DATA LOG FILE EXAMPLE

This page intentionally blank

Typical Uploaded Data log File (DPI 610)

The following gives details of a typical data file upload.

FILENAME: TEST 5
DATE: 21/10/2006
TIME: 15:58
TRIGGER: KEYPRESS
AMBIENT TEMP : 24.1 C

NO. OF POINTS 11
RECORD TYPE 0
CURRENT mA PRESSURE INT bar

3.902	0.008	-0.65	%span	21/10/2006	15:58:55
6.076	2.311	1.42	%span	21/10/2006	16:00:03
7.598	4.404	0.47	%span	21/10/2006	16:00:57
8.085	5.023	0.41	%span	21/10/2006	16:01:45
9.949	7.249	0.94	%span	21/10/2006	16:02:42
13.002	11.300	-0.23	%span	21/10/2006	16:03:30
17.005	16.102	0.77	%span	21/10/2006	16:05:00
17.766	17.106	0.51	%span	21/10/2006	16:06:07
17.812	17.105	0.80	%span	21/10/2006	16:07:49
18.532	17.965	1.00	%span	21/10/2006	16:16:35
20.007	20.212	-1.02	%span	21/10/2006	16:18:23

The Record Type number contained in the header is a 16-bit field, with the individual bits representing result formats as detailed below.

Record Type 1	P-Display
Record Type 2	Switch Test
Record Type 4	Leak Test
Record Type 8	Input channel: Min/Max ON
Record Type 120	Combination of all input process functions
Record Type 896	Combination of all output process functions
Record Type 1024	mA step mode
Record Type 2048	mA value mode
Record Type 4096	mA ramp mode
Record Type 8192	no input selected
Record Type 16384	no output selected

Typical Uploaded Procedure Data File (DPI 615)

The following gives details of a typical data file upload.

FILENAME: TEST 6
DATE: 21/10/2006
TIME: 15:58
TRIGGER: KEYPRESS
AMBIENT TEMP : 24.1 C

NO. OF POINTS 11
RECORD TYPE 0
CURRENT mA PRESSURE INT bar

3.902	0.008	-0.65	%span	PASS	21/10/2006	15:58:55
6.076	2.311	1.42	%span	FAIL	21/10/2006	16:00:03
7.598	4.404	0.47	%span	PASS	21/10/2006	16:00:57
8.085	5.023	0.41	%span	PASS	21/10/2006	16:01:45
9.949	7.249	0.94	%span	PASS	21/10/2006	16:02:42
13.002	11.300	-0.23	%span	PASS	21/10/2006	16:03:30
17.005	16.102	0.77	%span	PASS	21/10/2006	16:05:00
17.766	17.106	0.51	%span	PASS	21/10/2006	16:06:07
17.812	17.105	0.80	%span	PASS	21/10/2006	16:07:49
18.532	17.965	1.00	%span	PASS	21/10/2006	16:16:35
20.007	20.212	-1.02	%span	FAIL	21/10/2006	16:18:23

The Record Type number contained in the header is a 16-bit field, with the individual bits representing result formats as detailed below.

Record Type 1	P-Display
Record Type 2	Switch Test
Record Type 4	Leak Test
Record Type 8	Input channel: Min/Max ON
Record Type 120	Combination of all input process functions
Record Type 896	Combination of all output process functions
Record Type 1024	mA step mode
Record Type 2048	mA value mode
Record Type 4096	mA ramp mode
Record Type 8192	no input selected
Record Type 16384	no output selected

Appendix 2

ATEX Certificate of Conformity

intentionally left blank



EC-TYPE EXAMINATION CERTIFICATE

1

2

**Equipment or Protective System Intended for use
in Potentially Explosive Atmospheres
Directive 94/9/EC**

3

EC-Type Examination Certificate Number : **BAS02ATEX1174X**

4

Equipment or Protective System: **DPI 61X IS SERIES PRESSURE CALIBRATOR**

5

Manufacturer: **DRUCK LIMITED**

6

Address: **Groby, Leicestershire, LE6 0FH**

7

This equipment or protective system and any acceptable variation thereto is specified in the schedule to this certificate and the documents therein referred to.

8

The Electrical Equipment Certification Service, notified body number 600 in accordance with Article 9 of the Council Directive 94/9/EC of 23 March 1994, certifies that this equipment or protective system has been found to comply with the Essential Health and Safety Requirements relating to the design and construction of equipment and protective systems intended for use in potentially explosive atmospheres given in Annex II to the Directive.

The examination and test results are recorded in confidential Report N°

02(C)0340 dated 12 June 2002

9

Compliance with the Essential Health and Safety Requirements has been assured by compliance with:

EN 50014: 1997 + Amds 1 & 2 EN 50020: 1994 EN 50284: 1999

except in respect of those requirements listed at item 18 of the Schedule.

10

If the sign "X" is placed after the certificate number, it indicates that the equipment or protective system is subject to special conditions for safe use specified in the schedule to this certificate.

11

This EC-TYPE EXAMINATION CERTIFICATE relates only to the design and construction of the specified equipment or protective system. If applicable, further requirements of this Directive apply to the manufacture and supply of this equipment or protective system.

12

The marking of the equipment or protective system shall include the following:-

Ex II 1 G EEx ia IIC T4

This certificate may only be reproduced in its entirety and without any change, schedule included.

File No: EECS 0312/02/043

This certificate is granted subject to the general conditions of the Electrical Equipment Certification Service. It does not necessarily indicate that the apparatus may be used in particular industries or circumstances.



Electrical Equipment Certification Service
Health and Safety Executive
Harpur Hill, Buxton, Derbyshire, SK17 9JN, United Kingdom
Tel: +44(0)1298 28000 Fax: +44(0)1298 28244
Internet: www.baseefa.com e-mail: baseefa.info.eecs@hsl.gov.uk

IM CLEARE
DIRECTOR
2 July 2002



13

Schedule

14

EC-TYPE EXAMINATION CERTIFICATE N° BAS02ATEX1174X

15

Description of Equipment or Protective System

The **DPI 61X IS Series Pressure Calibrator** is a battery powered transportable instrument designed to measure pressure, voltage, current, switch status (open/closed) and ambient temperature, and display the data.

The DPI 61X IS Series Pressure Calibrator may be supplied with an internal pressure transducer fitted or a provision is made for an external pressure transducer to be fitted supplied with a cable assembly of 10 metres maximum length.

Provision is also made for the data to be transferred in the non-hazardous area via RS232 interface.

The Pressure Calibrator consists of two printed circuit boards one of which is partially encapsulated, batteries, optional internal pressure transducer and pneumatic components all housed within a two part moulded plastic enclosure.

The enclosure provides a Degree of Protection IP20.

The DPI 61X Series Pressure Calibrator is powered by six alkaline C size batteries IEC Type LR14. Access to the batteries is via a removable battery cover plate which is secured by two tamperproof screws.

The battery types which may be used are as follows:

Duracell Type MN1400-LR14
Procell Industrial Type MN1400-LR14
Energizer Type E93.LR14.C.AM2
Energizer Industrial Type EN93
Varta No 4014 Type LR14.C.AM2

The above batteries must only be changed in the non-hazardous area.

The pressure calibrator also contains two series connected lithium coin cells for memory back-up. These cells are directly soldered to the main printed circuit board and may be one of the following types:

Duracell Type DL2430
Varta Type CR2430
FDK Type CR2430

Intrinsic safety is assured by limitation of voltage, current, power, limitation of capacitance, limitation and suppression of inductance and infallible segregation.



13

Schedule

14

EC-TYPE EXAMINATION CERTIFICATE N° BAS02ATEX1174X

The maximum output parameters at the external measurement connectors are:

IIN (SK1)

$U_o = 1.1V$ d.c.
 $I_o = 0.16$ mA d.c.
 $P_o = 0.15$ mW

$C_i = 0.05\mu F$
 $L_i = 0$

VIN (SK2)

$U_o = 1.1V$ d.c.
 $I_o = 0.11$ μA d.c.
 $P_o = 0.03\mu W$

$C_i = 0$
 $L_i = 0$

SWITCHIN (SK3)

$U_o = 1.1V$ d.c.
 $I_o = 12$ mA d.c.
 $P_o = 11$ mW

$C_i = 0.05\mu F$
 $L_i = 0$

IOUT (SK6)

$U_o = 7.9V$ d.c.

$C_i = 0$
 $L_i = 0.1$ mH

RS232

$U_o = 7.6V$ d.c.
 $I_o = 82$ mA d.c.
 $P_o = 162$ mW

$C_i = 0$
 $L_i = 0$

$U_m = 250V$



13

Schedule

14

EC-TYPE EXAMINATION CERTIFICATE N° BAS02ATEX1174X

External Transducer

$U_o = 7.9\text{V d.c.}$
 $I_o = 155\text{ mA d.c.}$
 $P_o = 0.43\text{W}$

$C_i = 0.15\mu\text{F}$
 $L_i = 0.9\text{ mH}$
 $C_o = 8.6\mu\text{F}$
 $L_o = 0.3\text{ mH}$

The output parameters at sockets SK1, SK2 and SK3 do not exceed the values specified in Clause 5.4, Simple Apparatus, of EN 50020.

The maximum safe input parameters are:

Sockets SK1, SK2, SK3 and SK6:

$U_i = 30\text{V}$
 $I_i = 100\text{ mA}$
 $P_i = 1.0\text{W}$

VARIATION 0.1

To permit an increase in the maximum ambient temperature from +40°C to +50°C by restricting the batteries to the Varta No 4014 Type LR14. C.AM2.

The revised code is EEx ia IIC T4 (-20°C ≤ T_a ≤ +50°C).

VARIATION 0.2

To permit the DPI 61X IS Series Pressure Calibrator to be alternatively known as a P330 Pressure Calibrator, a DPI 61X IS Series Pressure Validator or a P330 Pressure Validator.

16

Report No

02(C)0340

17

Special Conditions For Safe Use

1. The DPI 61X IS Series Pressure Calibrator is not capable of withstanding the 500V r.m.s. electric strength test between the external connectors and frame of the apparatus as required by Clause 6.4.12 of EN 50020 and this must be taken into account when using the apparatus for input measurements in a system.



13

Schedule

14

EC-TYPE EXAMINATION CERTIFICATE N° BAS02ATEX1174X

2. The outer enclosure may contain light metals in the form of aluminium, magnesium, titanium or zirconium. Therefore, the apparatus must be installed in such a manner as to prevent the possibility of it being subjected to impacts or friction.

18

Essential Health and Safety Requirements

ESSENTIAL HEALTH & SAFETY REQUIREMENTS not covered by standards listed in Section 9		
Clause	Subject	Compliance
1.1.3	Changes in characteristics of materials and combinations thereof	Report No 02(C)0340 Clause 5.1.1.3
1.2.2	Components for incorporation or replacement	Report No 02(C)0340 Clause 5.1.2.2
1.2.4	Dust deposits	Report No 02(C)0340 Clause 5.1.2.4
1.2.5	Additional means of protection	Report No 02(C)0340 Clause 5.1.2.5
1.4.2	Withstanding attack by aggressive substances	Report No 02(C)0340 Clause 5.1.4.2

19

DRAWINGS

Number	Issue	Date	Description
E-A3-2333, Sheets 1 & 2	2	12.1.99	General Assembly
E-A3-2345, Sheets 1 to 4	2	11.1.99	Transducer Details
E-A3-2329	4	11.6.02	Label Details
E-A2-2459, Sheets 1 to 5	2	11.1.99	Schematic - Main Board
E-A1-2455, Sheets 1 & 2	2	13.1.99	PCB Assembly - Main Board
E-A1-2457, Sheets 1 & 2	2	12.11.98	PCB Artwork - Main Board
E-A2-2458	3	27/05/99	Circuit Diagram, Switch Board
E-A2-2454	3	26.05.99	PCB Assembly, Switch Board
E-A2-2456 Sheet 1 of 3	3	26.05.99	PCB Drilling Details, Switch Board
E-A2-2456 Sheet 2 of 3	3	26.05.99	PCB Artwork Details, Switch Board
E-A2-2456 Sheet 3 of 3	3	26.05.99	PCB Legend Details, Switch Board

This certificate may only be reproduced in its entirety and without any change, schedule included.

BASEEFA List Keywords
2PRESMEA



1 **SUPPLEMENTARY EC - TYPE EXAMINATION CERTIFICATE**

2 **Equipment or Protective System Intended for use in Potentially Explosive Atmospheres
Directive 94/9/EC**

- 3 Supplementary EC - Type Examination Certificate Number: **BAS02ATEX1174X/1**
- 4 Equipment or Protective System: **DPI 61X Series Pressure Calibrator**
- 5 Manufacturer: **Druck Limited**
- 6 Address: **Groby, Leicester, LE6 0FH**
- 7 This supplementary certificate extends EC – Type Examination Certificate No. BAS02ATEX1174X to apply to equipment or protective systems designed and constructed in accordance with the specification set out in the Schedule of the said certificate but having any variations specified in the Schedule attached to this certificate and the documents therein referred to.

This supplementary certificate shall be held with the original certificate.

The original certificate was issued by The Electrical Equipment Certification Service, Notified Body Number 0600, which retains responsibility for its original documentation. Baseefa (2001) Ltd., Notified Body Number 1180, is responsible only for the additional work relating to this supplementary certificate and any other supplementary certificate it has issued.

This certificate may only be reproduced in its entirety, without any change, schedule included.

Baseefa (2001) Ltd. Customer Reference No. **0312**

Project File No. **04/0343**

This certificate is granted subject to the general terms and conditions of Baseefa (2001) Ltd. It does not necessarily indicate that the equipment may be used in particular industries or circumstances.

Baseefa (2001) Ltd.

Health and Safety Laboratory Site, Harpur Hill,
Buxton, Derbyshire SK17 9JN
Telephone +44 (0) 1298 28255 Fax +44 (0) 1298 28216
e-mail info@baseefa2001.biz web site www.baseefa2001.biz
Registered in England No. 4305578 at 13 Dovedale Crescent, Buxton,
Derbyshire, SK17 9BJ

R S SINCLAIR
DIRECTOR
On behalf of
Baseefa (2001) Ltd.



13

Schedule

14

Certificate Number BAS02ATEX1174X/1

15 **Description of the variation to the Equipment or Protective System**

Variation 1.1

To permit minor electrical changes that do not affect the original intrinsic safety assessment.

16 **Report Number**

None

17 **Special Conditions for Safe Use**

None additional to those listed previously

18 **Essential Health and Safety Requirements**

Compliance with the Essential Health and Safety Requirements is not affected by this variation.

19 **Drawings and Documents**

Number	Sheet	Issue	Date	Description
E-A2-2459	1 to 5	3	26.10.04	DPI 61X IS Pressure Calibrator Main Board Circuit Diagram for Baseefa



1 **SUPPLEMENTARY EC - TYPE EXAMINATION CERTIFICATE**

2 **Equipment or Protective System Intended for use in Potentially Explosive Atmospheres
Directive 94/9/EC**

3 Supplementary EC - Type **BAS02ATEX1174X/2**
Examination Certificate Number:

4 Equipment or Protective System: **DPI 61X IS Series Pressure Calibrator**

5 Manufacturer: **Druck Ltd**

6 Address: **Grobby, Leicester, LE6 0FH**

7 This supplementary certificate extends EC – Type Examination Certificate No. BAS02ATEX1174X to apply to equipment or protective systems designed and constructed in accordance with the specification set out in the Schedule of the said certificate but having any variations specified in the Schedule attached to this certificate and the documents therein referred to.

This supplementary certificate shall be held with the original certificate.

The original certificate was issued by The Electrical Equipment Certification Service, Notified Body Number 0600, which retains responsibility for its original documentation. Baseefa (2001) Ltd., Notified Body Number 1180, is responsible only for the additional work relating to this supplementary certificate and any other supplementary certificate it has issued.

This certificate may only be reproduced in its entirety, without any change, schedule included.

Baseefa Customer Reference No. 0312

Project File No. 05/0213

This certificate is granted subject to the general terms and conditions of Baseefa (2001) Ltd. It does not necessarily indicate that the equipment may be used in particular industries or circumstances.

Baseefa

Rockhead Business Park, Staden Lane,
Buxton, Derbyshire SK17 9RZ
Telephone +44 (0) 1298 766600 Fax +44 (0) 1298 766601
e-mail info@baseefa.com web site www.baseefa.com
Baseefa is a trading name of Baseefa (2001) Ltd
Registered in England No. 4305578 at the above address

R S SINCLAIR
DIRECTOR
On behalf of
Baseefa (2001) Ltd.



13

Schedule

14

Certificate Number BAS02ATEX1174X/2

15 **Description of the variation to the Equipment or Protective System**

Variation 2.1

To permit minor modifications to the certified drawings which do not affect the intrinsic safety assessment.

16 **Report Number**

None

17 **Special Conditions for Safe Use**

None additional to those listed previously

18 **Essential Health and Safety Requirements**

Compliance with the Essential Health and Safety Requirements is not affected by this variation.

19 **Drawings and Documents**

Number	Sheet	Issue	Date	Description
E-A3-2329	1	5	19.04.05	DPI 61X IS Series Marking Details



1 **SUPPLEMENTARY EC - TYPE EXAMINATION CERTIFICATE**

2 **Equipment or Protective System Intended for use in Potentially Explosive Atmospheres
Directive 94/9/EC**

- 3 Supplementary EC - Type Examination Certificate Number: **BAS02ATEX1174X/3**
- 4 Equipment or Protective System: **DPI 61X Series Pressure Calibrator**
- 5 Manufacturer: **Druck Limited**
- 6 Address: **Groby, Leicester, LE6 0FH**

7 This supplementary certificate extends EC – Type Examination Certificate No. BAS02ATEX1174X to apply to equipment or protective systems designed and constructed in accordance with the specification set out in the Schedule of the said certificate but having any variations specified in the Schedule attached to this certificate and the documents therein referred to.

This supplementary certificate shall be held with the original certificate.

The original certificate was issued by The Electrical Equipment Certification Service, Notified Body Number 0600, which retains responsibility for its original documentation. Baseefa (2001) Ltd., Notified Body Number 1180, is responsible only for the additional work relating to this supplementary certificate and any other supplementary certificate it has issued.

This certificate may only be reproduced in its entirety, without any change, schedule included.

Baseefa Customer Reference No. **0312**

Project File No. **06/0905**

This certificate is granted subject to the general terms and conditions of Baseefa (2001) Ltd. It does not necessarily indicate that the equipment may be used in particular industries or circumstances.

Baseefa
Rockhead Business Park, Staden Lane,
Buxton, Derbyshire SK17 9RZ
Telephone +44 (0) 1298 766600 Fax +44 (0) 1298 766601
e-mail info@baseefa.com web site www.baseefa.com
Baseefa is a trading name of Baseefa (2001) Ltd
Registered in England No. 4305578 at the above address

R S SINCLAIR
DIRECTOR
On behalf of
Baseefa (2001) Ltd.



13

Schedule

14

Certificate Number BAS02ATEX1174X/3

15 **Description of the variation to the Equipment or Protective System**

Variation 3.1

To permit the optional addition of a carrying case for transporting the equipment to and from the location of use. The case is made from a combination of leather and natural fibre. The Special Conditions do not apply whilst the equipment is in transit in the carrying case.

16 **Report Number**

None

17 **Special Conditions for Safe Use**

None additional to those listed previously

18 **Essential Health and Safety Requirements**

Compliance with the Essential Health and Safety Requirements is not affected by this variation.

19 **Drawings and Documents**

Number	Issue	Date	Description
X-A3-0258	1	14-Aug-06	DPI610IS Carry Case

Certificate Number
BAS02ATEX1174X/4



Issued 21 May 2008
Page 1 of 2

1 **SUPPLEMENTARY TYPE EXAMINATION CERTIFICATE**

2 **Equipment Intended for use in Potentially Explosive Atmospheres
Directive 94/9/EC**

3 Supplementary Type Examination Certificate Number: **BAS02ATEX1174X/4**

4 Equipment: **DPI 61X Series Pressure Calibrator**

5 Manufacturer: **Druck Limited**

6 Address: **Groby, Leicester, LE6 0FH**

7 This supplementary certificate extends Type Examination Certificate No. BAS02ATEX1174X to apply to equipment designed and constructed in accordance with the specification set out in the Schedule of the said certificate but having any variations specified in the Schedule attached to this certificate and the documents therein referred to.

This supplementary certificate shall be held with the original certificate.

The original certificate was issued by The Electrical Equipment Certification Service, which retains responsibility for its original documentation. Baseefa is responsible only for the additional work relating to this supplementary certificate and any other supplementary certificate it has issued.

This certificate may only be reproduced in its entirety, without any change, schedule included.

Baseefa Customer Reference No. **0312**

Project File No. **08/0344**

This certificate is granted subject to the general terms and conditions of Baseefa. It does not necessarily indicate that the equipment may be used in particular industries or circumstances.

Baseefa

Rockhead Business Park, Staden Lane,
Buxton, Derbyshire SK17 9RZ
Telephone +44 (0) 1298 766600 Fax +44 (0) 1298 766601
e-mail info@baseefa.com web site www.baseefa.com
Baseefa is a trading name of Baseefa Ltd
Registered in England No. 4305578. Registered address as above.



R S SINCLAIR
DIRECTOR
On behalf of
Baseefa



13

Schedule

14

Certificate Number BAS02ATEX1174X/4

15 **Description of the variation to the Equipment**

Variation 4.1

To permit electrical changes that do not affect the existing intrinsic safety assessment.

16 **Report Number**

None.

17 **Special Conditions for Safe Use**

None additional to those listed previously

18 **Essential Health and Safety Requirements**

Compliance with the Essential Health and Safety Requirements is not affected by this variation.

19 **Drawings and Documents**

Number	Sheet	Issue	Date	Description
E-A2-2458	1	4	07/05/08	DPI61XiS Series Pressure Calibrator Switch Board Circuit Diagram For Baseefa
E-A2-2454	1	4	14.05.08	DPI61XiS Series Pressure Calibrator Switch Bd. Assembly Drg. For Baseefa
X-A3-0308	1	1	29.APR.08	DPI610IS Modified LCD Display OG16161WFST Baseefa



1 **SUPPLEMENTARY EC - TYPE EXAMINATION CERTIFICATE**

2 **Equipment or Protective System Intended for use in Potentially Explosive Atmospheres
Directive 94/9/EC**

3 Supplementary EC - Type Examination Certificate Number: **BAS02ATEX1174X/5**

4 Equipment or Protective System: **DPI 61X Series Pressure Calibrator**

5 Manufacturer: **Druck Limited**

6 Address: **Groby, Leicester, LE6 0FH, UK**

7 This supplementary certificate extends EC - Type Examination Certificate No. BAS02ATEX1174X to apply to equipment or protective systems designed and constructed in accordance with the specification set out in the Schedule of the said certificate but having any variations specified in the Schedule attached to this certificate and the documents therein referred to.

This supplementary certificate shall be held with the original certificate.

The original certificate was issued by The Electrical Equipment Certification Service, Notified Body Number 0600, which retains responsibility for its original documentation. Baseefa, Notified Body Number 1180, is responsible only for the additional work relating to this supplementary certificate and any other supplementary certificate it has issued.

This certificate may only be reproduced in its entirety, without any change, schedule included.

Baseefa Customer Reference No. **0312**

Project File No. **08/0488**

This certificate is granted subject to the general terms and conditions of Baseefa. It does not necessarily indicate that the equipment may be used in particular industries or circumstances.

Baseefa

Rockhead Business Park, Staden Lane,
Buxton, Derbyshire SK17 9RZ
Telephone +44 (0) 1298 766600 Fax +44 (0) 1298 766601
e-mail info@baseefa.com web site www.baseefa.com
Baseefa is a trading name of Baseefa Ltd
Registered in England No. 4305578. Registered address as above.

A handwritten signature in black ink, appearing to read "R S Sinclair".

R S SINCLAIR
DIRECTOR
On behalf of
Baseefa



13

Schedule

14

Certificate Number BAS02ATEX1174X/5

15 **Description of the variation to the Equipment or Protective System**

Variation 5.1

To confirm that the equipment covered by this certificate has been reviewed against the requirements of EN 60079-0: 2006, EN 60079-11: 2007 and EN 60079-26: 2007 in respect of differences from EN 50014: 1997 + Amendments 1 & 2, EN 50020: 1994 and EN 50284: 1999, and that none of these differences affect this equipment.

The equipment is to be marked: Ⓢ II 1G Ex ia IIC T4 Ga (or Ⓢ II 1G Ex ia IIC T4 Ga (-20°C ≤ Ta ≤ +50°C) where the batteries are restricted to Varta 4014 Type LR14.C.AM2).

16 **Report Number**

08(C)0488-5

17 **Special Conditions for Safe Use**

None additional to those listed previously.

18 **Essential Health and Safety Requirements**

Compliance with the Essential Health and Safety Requirements is not affected by this variation.

19 **Drawings and Documents**

Number	Sheet	Issue	Date	Description
E-A3-2329	1 to 2	6	01.12.08	DPI 61X IS Series Marking Details for Baseefa Certification

intentionally left blank